

**MATEC**  
GmbH

**THE MODULAR EVOLUTION**  
SERIES HVC | HV | HVU | U



## EDITORIAL



Dear Sir or Madam,

Now that you have opened our product catalogue, you may be wondering what distinguishes MATEC machining centres from those of the other manufacturers?

Is it the fact that in times of globalisation and worldwide interwoven supply chains we continue to consistently focus on MADE IN GERMANY or rather even MADE IN KÖNGEN?

Or is it because of the MATEC modular system, which offers our customers an almost limitless variety of solutions? Solutions that leave more room for ideas than preconfigured product groups - **THE MODULAR EVOLUTION**, so to speak?

Could it be the employees in Köngen who put their heart and soul and engineering skills into the quality and durability of our machines every day and for whom customers are much more than just buyers? Is it the employees who are proud of our machines because they know that they produce individual solutions for our customers for their current and future added value?

Is it perhaps the mixture of tradition and innovation that drives us forward time and again with new solutions for the new challenges faced by our customers? Or it might indeed be our ambition to find the ideal solution together with the customer.

After all, our customers are as individual as our solutions: From contract manufacturers with individual series production to corporate customers. We have a relationship of trust with both of them that has grown over the years. It is also always amazing to see how diverse, and occasionally exotic, the industries are in which we find ourselves.

It is probably the combination of all these factors that makes our product and sets us apart.

We would, therefore, like to invite you to discover the MATEC diversity on the pages that follow, irrespective of whether you are already producing on MATEC machines or are just getting to know us.

And by the way ... it is not only the individual customer-related solutions for which we are known. You can also check out our HVC series in the standard range, which offers ideal entry-level models with short delivery times and a wide range of options.

And last but not least, we believe that a compelling product always goes hand in hand with a service that wins you over.

All our customers know that they can count on the quality of our service.

Best regards,  
Jürgen Wolf  
Sales Manager  
MATEC GmbH

## CONTENTS

Here is our series (model-independent) and its performance class:  
Performance class HSK63 | SK40 → MATEC 30 | MATEC 60  
Performance class HSK100 | SK50 → MATEC 40 | MATEC 50 | MATEC 70



Page 10 - 17

**Standard HVC machining centres**

Standard machines with high-quality basic equipment and short delivery times



Page 18 - 19

**30SHV machining centre**

for series production with swivel table and swivel head



Page 20 - 31

**Modular HV machining centres**

for customised production



Page 32 - 41

**HVU machining centres**

with 2-axis swivel head



Page 42 - 59

**Special solutions**



Page 60 - 63

**Other machine series**

# MATEC

## Our STRENGTHS

**IN FOCUS** Our customers' requirements and innovative developments in the supplier industry.  
**AS BASIS** The MATEC modular system which keeps growing with its requirements.  
**OUR KNOW-HOW** The combination of state-of-the-art technologies with innovative mechanical engineering.

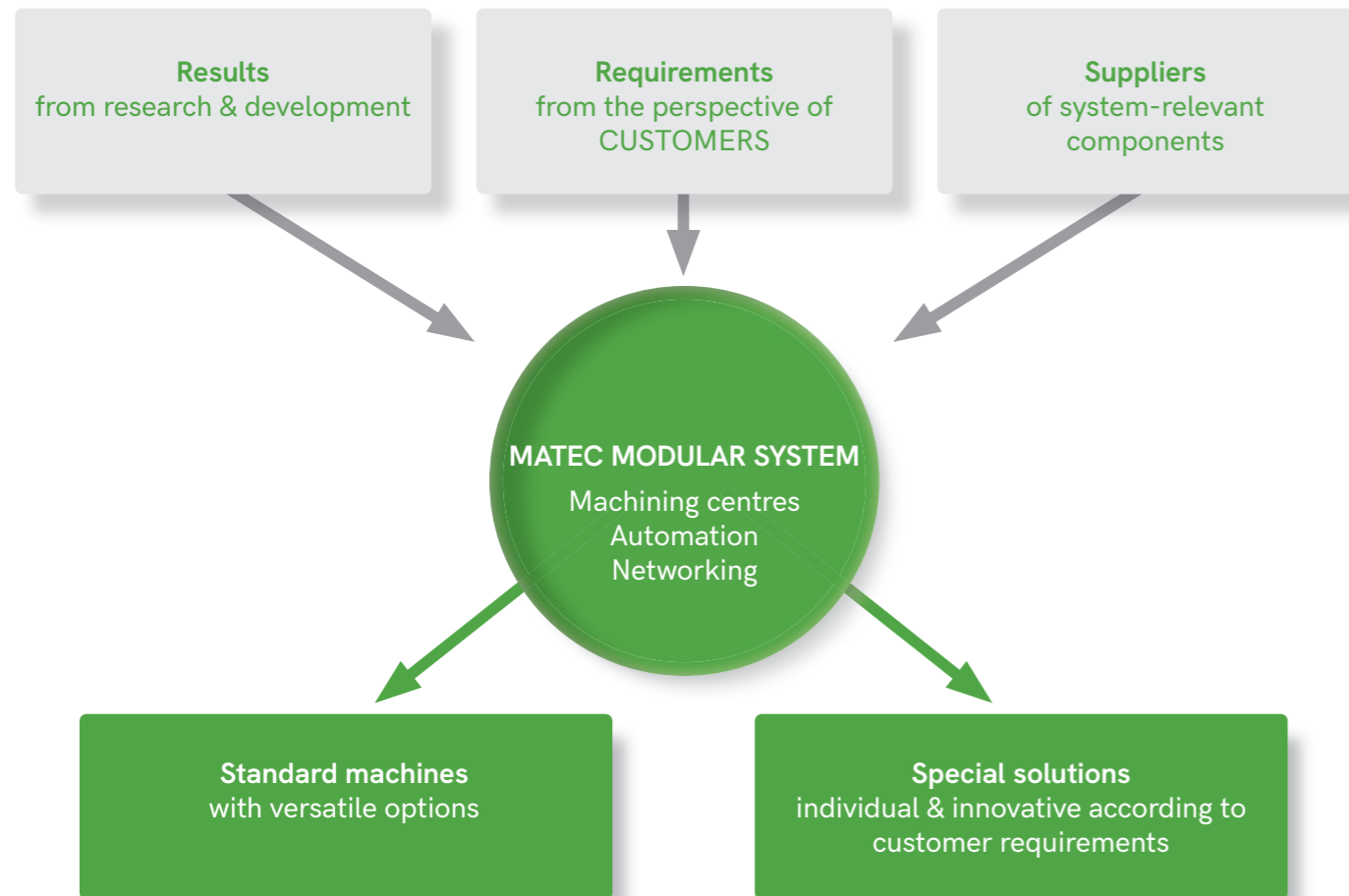

### The MATEC modular system

With the MATEC modular system, we create modern production solutions for our customers. We create these solutions by allowing standard modules to be combined with each other in almost every conceivable way within a specific group of machines. This results in a wide variety of special solutions, but also standard machines that can do much more than the term "standard" suggests, thanks to additional equipment such as swivel bridges with multiple clamping, rotary tables, sawing units, angular and multi-spindle heads. Thanks to their modular design, our machining centres can also be retrofitted or converted to new production conditions at any time.

### Efficiency and yield

Special solutions in combination with our MATEC modular system will guarantee you economic success. We create special solutions based on standard modules and save you expensive development costs. In addition, our special solutions based on standard modules are reliable and process-safe because they have been tried and tested over many years and are used in a variety of applications. This is how we guarantee our customers competitiveness and added value now and in the future! You can always count on our know-how. You will find some examples of special solutions in the brochure starting on page 42.



### MATEC - represented everywhere

Our representatives and specialist dealers in Germany and abroad will be pleased to offer you their expert advice and help you understand which MATEC solution is the best and most cost-effective for your machining task whilst ensuring that your company is well equipped for the future.

### MATEC employees promote our values

They are proud of their company and our products. We train our skilled workers in-house. Be it as part of an apprenticeship as an industrial mechanic, product designer or industrial clerk or as part of a dual course of study in mechanical engineering or electronics at the DHBW. In this way, our employees of tomorrow get to know our machines and our values and high standards in technology and quality already during their training and know what is important to us and what drives us every day. This is also part of our innovative strength!

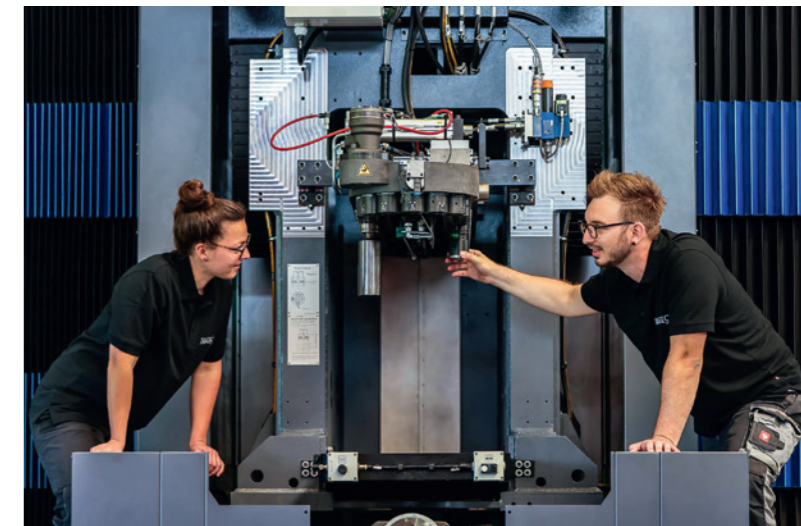

### MATEC service - our promise to you

- We are at your disposal at any time, either by telephone via hotline, online via remote maintenance or in person at the place of operation in your company.
- Our team of long-term qualified service technicians on the MATEC hotline has the answers to your questions. Competent and friendly.
- For us, customers are people whom we treat as partners, because we are only satisfied when they are satisfied.
- We quickly make spare parts available to you.
- Via remote maintenance, we help with many questions without you having to call in a service technician immediately.
- In the event of an on-site visit, a friendly team of MATEC field service technicians will be at your side, working for you throughout Germany and in many countries via our representatives.

**Precision - that's what we are all about!**

A machine tool must be considerably better in terms of precision than the required workpiece tolerance. It is our passion to do just that! That is why we are all about precision and we are not afraid to express this claim in concrete values! Anyone familiar with metal machining knows that deviations in shape and position under conditions of statistical quality targets can considerably reduce the tolerance values specified in workpiece drawings. Thus, supposedly controllable tolerances can add up to an undesirable result in retrospect. That is why we at MATEC pay special attention to the accuracy of purchased parts such as linear guides and ball screws, in addition to all mechanical engineering knowledge, because they are the basis for the precision and service life of every machine. We are also not content with simply putting high-quality machine components together, because even precision parts can have manufacturing tolerances that can add up during the course of machining.

We determine deviations in advance according to exact specifications and with precise measuring methods and reduce them to the best possible minimum - if necessary, even with manual labour. That is just how much our promise of precision is worth to us! We are also particularly attentive to the straightness of guide rails. After all, any inaccuracy in the guide is reflected in the workpiece. The same applies to ball screws. By consistently adhering to our high standards, we fall well below the accuracy specifications for machine tools according to DIN/ISO 230. Our recorded laser measurement diagrams bear testimony to the fact that we have indeed pulled it off. This demand for stability and precision has always set MATEC apart from the market. This is what our customers expect from a MATEC machine and whoever has this demand for quality, stability and precision as a customer in the future knows that he will get it fulfilled with us.

**Laser measurement straightness of roller linear guide (example X-axis 2,000 mm)**  
Deviation + 4 µm / - 3 µm on 2,000 mm length of parallel

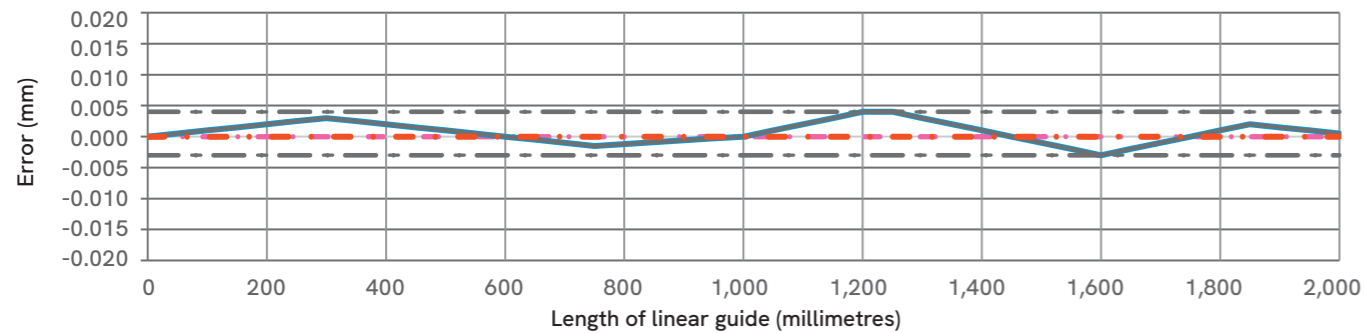

**Standard: VDI/DGQ (German Association for Quality) 3441 (Example: Laser measurement of ball screw X-axis)**  
Position uncertainty P total 2.847 µm on 2,000 mm axis length

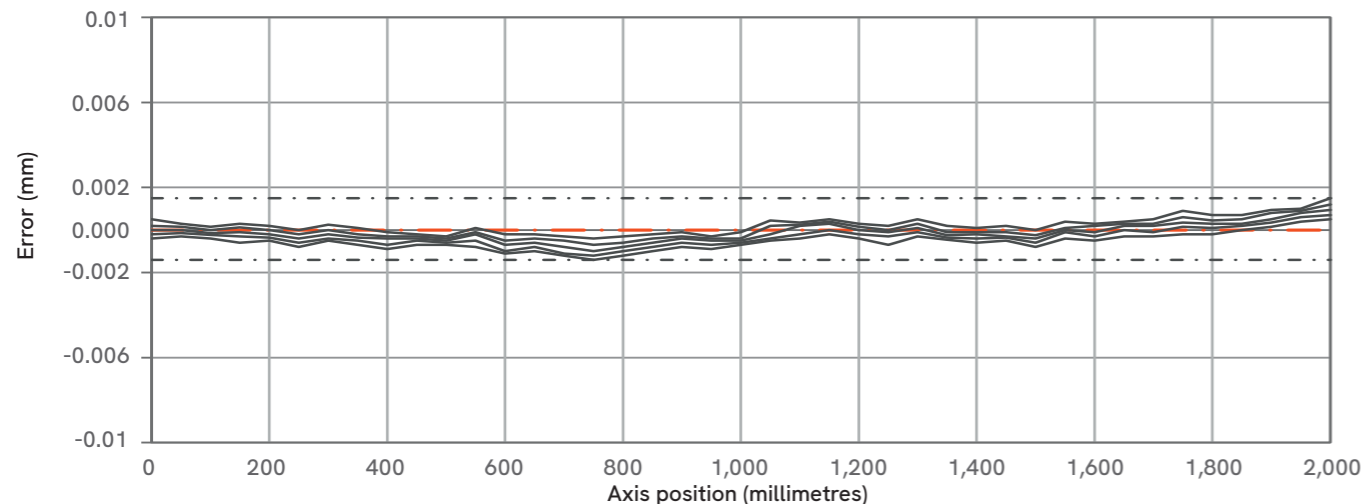

Machine: MATEC 30HVC	Date: 17.03.2021	Axis: X	U max: 0.267 µm
Serial no. 1617	Time: 17:51:20	Axle length / measuring length: 2,000 mm	P: 2.847 µm
	Name: Müller	U with: 0.092 µm	Ps max: 2.168 µm
		Ps with: 0.570 µm	Pa: 2.000 µm

**Our stability guarantee**

With a MATEC machining centre, you are opting for absolute stability. This is because it is the only way to ensure optimum machining conditions and high-precision workpieces. How do we do this? By examining exactly where and how forces act on machines. In 5-sided or 5-axis machining, the machine must be able to absorb spatial forces in all directions. Not only the reaction force that occurs during machining plays a role, but also the often underestimated elasticity of machine components. We, at MATEC, are not satisfied with this and therefore our machines are designed such that compliance is minimised and resonances are avoided. By means of pyramid-shaped component structures in the form of almost isosceles triangles, machining forces are transmitted in a strut-like manner from the main spindle to the machine bed and the hall floor or the foundation. With MATEC, undesirable vibrations caused by elastic machine components do not occur in the first place. What's in it for you? Perfect machining surfaces and a long service life of the tools used.

**Triangle of forces Y- and Z-axis**

The guiding distance of Y- and Z-axis is constructively oriented to the traverse paths of the machine. According to the defined standard sizes of Y- and Z-axis, the guide distances also change. With the ideal triangle of forces, we provide the necessary support so that you can also perfectly machine high workpieces in the uppermost Z-axis position.

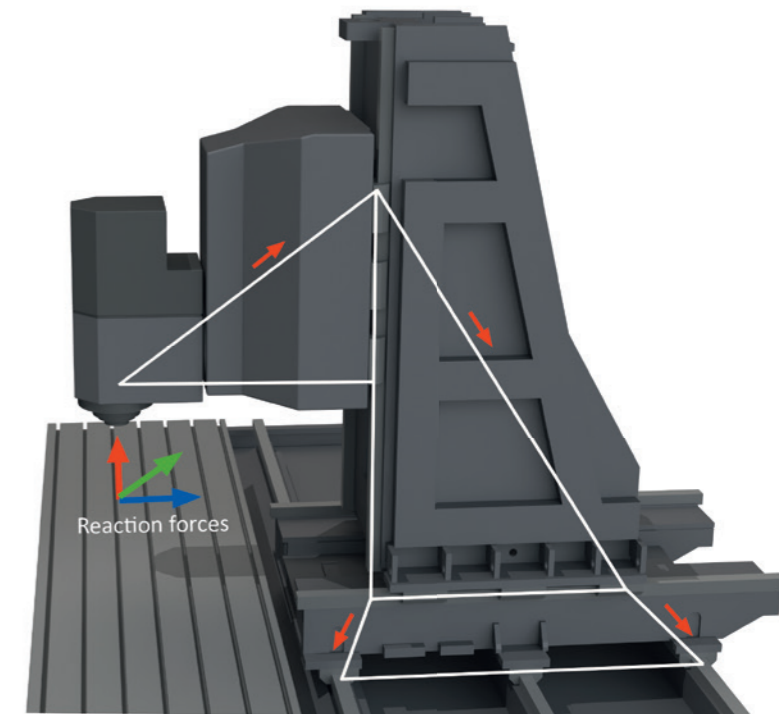

**Machine table**

Top-mounted work table made of high-quality, fine-pored grey cast iron. We pay special attention to the alignment of the table to the individual axes: After all linear axes have been set exactly to each other, the machine table is adjusted in flatness, parallelism and perpendicularity to the machine axes and then firmly connected to the machine bed. This achieves a flatness in the range of 0.01 mm over the entire table surface.

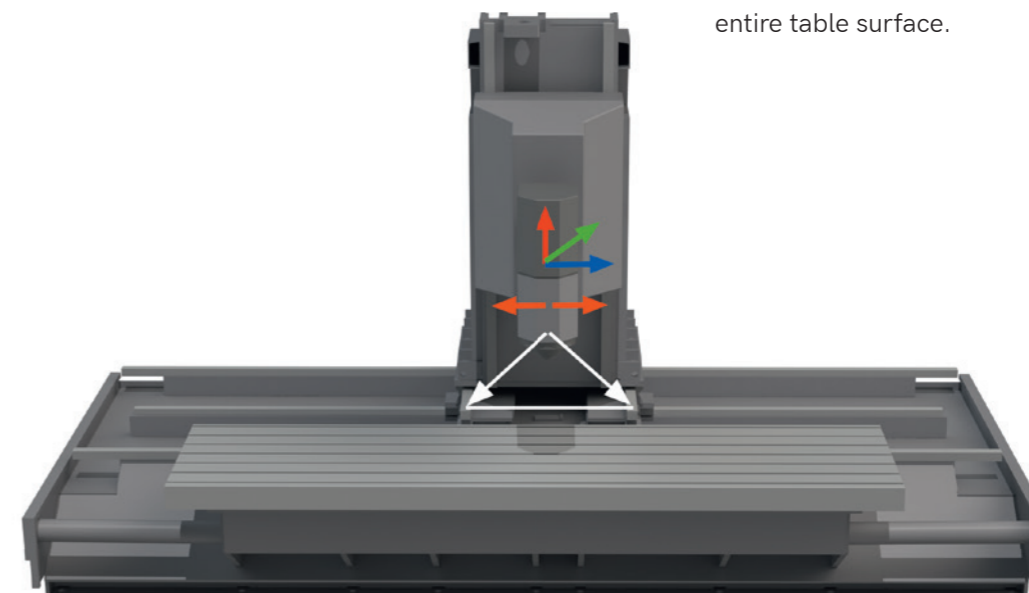

# MATEC

## Standard | Modular | Special solutions

**THE MODULAR EVOLUTION:** Innovative product diversity for every manufacturing process, from standard machines to customised machining centres.

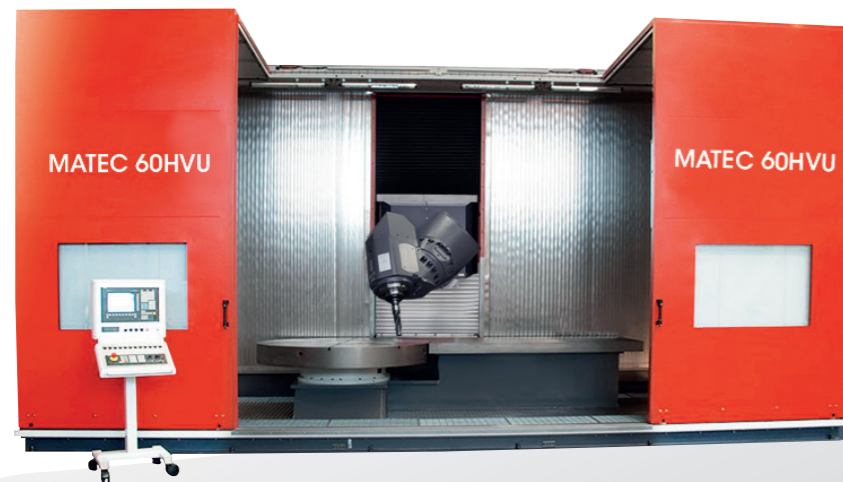

# MATEC 30HVC

## 5-Axis standard machining centres

### Performance class HSK63

The standard machine for complex 5-side machining

- High stability and precision
- Short delivery times



### Available machine sizes:

	MATEC 30HVC							
X-axis in mm	1,300	1,500	3,000	3,000	3,000	4,000	4,000	4,000
Y-axis in mm	600	825	825	1,125	1,125	825	1,125	1,125
Z-axis in mm	800	1,100	1,100	1,100	1,300	1,100	1,100	1,300

## Standard equipment in all machines

### Standard equipment

- 1-Axis CNC swivel head, infinitely variable
- Heidenhain TNC 640 control
- Tool holder HSK63 DIN 69893
- Tool magazine 48 places
- CNC rotary table Ø 630 / 800 / 1,150 mm
- Work area full enclosure with roof
- Direct path measuring system in X-, Y- and Z-axis
- Chip conveyor

### Additional options

- Siemens 840D sl
- Tool holder SK40 DIN 69871
- Tool magazine extension to 280 places
- High-pressure coolant unit
- Rotary tables mounted for shaft machining
- Work area partition wall

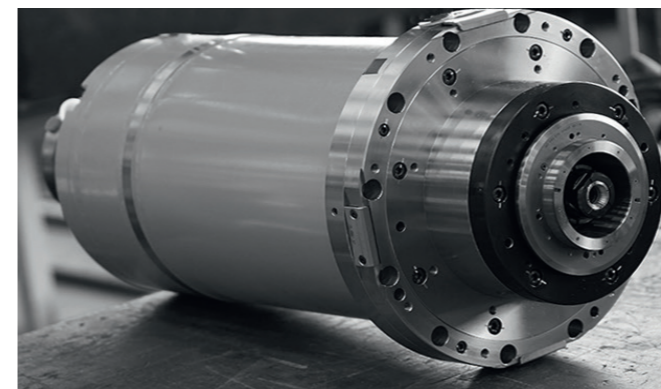

### Motor spindle

Speed: 9,000 1/min  
 Power max: 19 kW  
 Torque max: 115 Nm  
 Tool holder: HSK63 | SK40

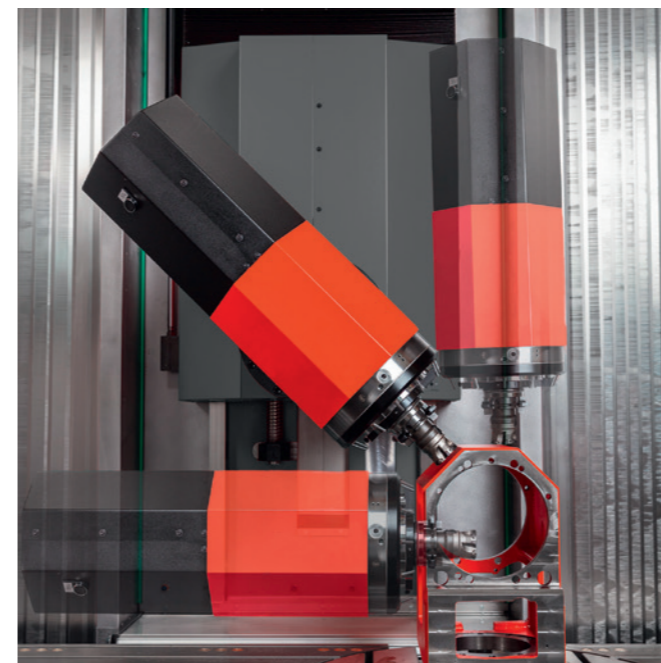

### Swivel head

Swivel angle: ± 105° degrees infinitely variable  
 Direct path measuring system: ± 3"  
 Clamping forces: 2,400 Nm unclamped  
 4,200 Nm clamped

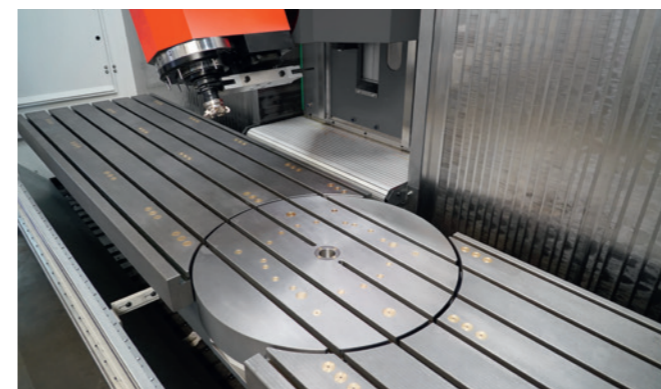

### Integrated CNC rotary table

For Y-axis 600 mm: Ø 630 mm  
 For Y-axis 825 mm: Ø 800 mm  
 For Y-axis 1,125 mm: Ø 1,150 mm

# MATEC 40HVC | 50HVC

## 5-Axis standard machining centres

### Performance class HSK100

The standard machine for complex 5-side machining

- High stability and precision
- Short delivery times



### Available machine sizes:

MATEC 40HVC							
X-axis in mm	1,500	3,000	3,000	3,000	4,000	4,000	4,000
Y-axis in mm	825	825	1,125	1,125	825	1,125	1,125
Z-axis in mm	1,100	1,100	1,100	1,300	1,100	1,100	1,300

MATEC 50HVC							
X-axis in mm	3,000	3,000	3,000	4,000	4,000	4,000	4,000
Y-axis in mm	825	1,125	1,125	825	1,125	1,125	1,125
Z-axis in mm	1,100	1,100	1,300	1,100	1,100	1,100	1,300

### Standard equipment in all machines

#### Standard equipment

- 1-Axis CNC swivel head, infinitely variable
- Heidenhain TNC 640 control
- Tool holder HSK100
- Tool magazine 40 places
- CNC rotary table Ø 800 / 1,150 mm
- Work area full enclosure with roof
- Direct path measuring system in X-, Y- and Z-axis
- Chip conveyor

#### Additional options

- Siemens 840D sl
- Tool holder SK50
- Tool magazine extension to 172 places
- High-pressure coolant unit
- Rotary tables mounted for shaft machining
- Work area partition wall

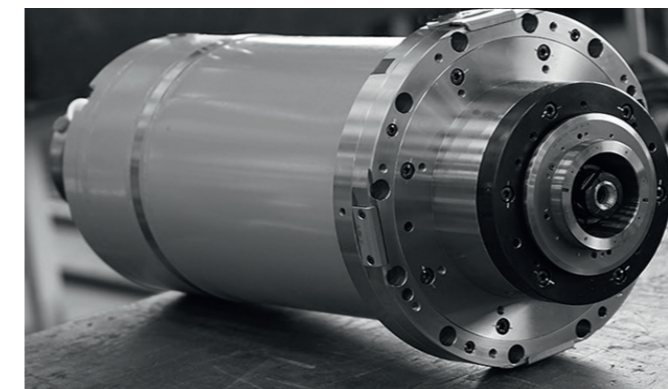

#### Motor spindle

Speed: 8,000 1/min  
 Power max: 42 kW  
 Torque max: 265 Nm  
 Tool holder: HSK100 | SK50

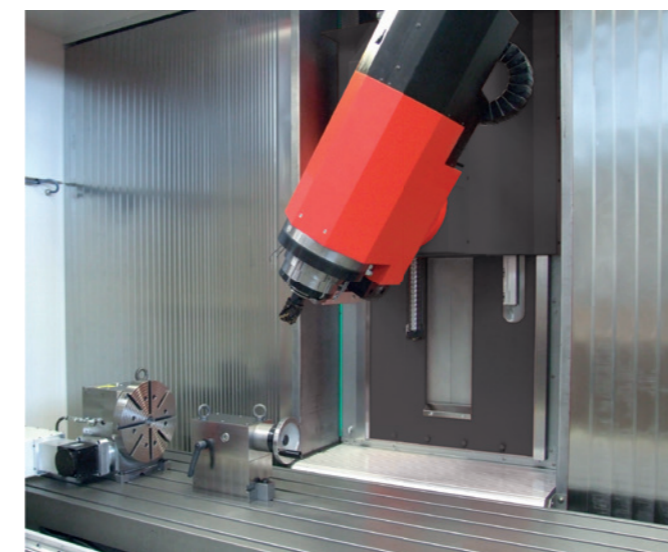

#### Swivel head

Swivel angle: ± 105° degrees infinitely variable  
 Direct path measuring system: ± 3"  
 Clamping forces: 2,400 Nm unclamped  
 4,200 Nm clamped

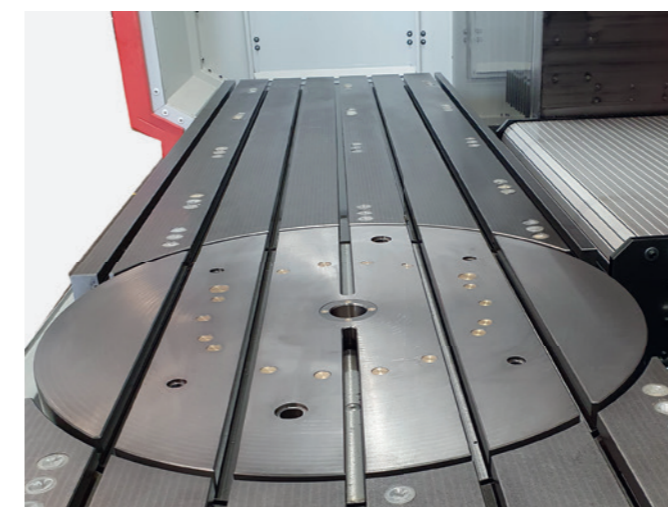

#### Integrated CNC rotary table

Y-axis 825 mm: Ø 800 mm  
 Y-axis 1,125 mm: Ø 1,150 mm

## MATEC HVC

### Standard group

### Tool changing systems

#### Double gripper

Tool magazine with double gripper  
(standard for 30HVC | 40HVC)

- For HSK63 with 48 tool places
- For HSK100 with 40 tool places
- Travelling in X- and Y-axis
- Tool change above the workpiece in any X- and Y-position
- Option: Tool change when moving the X-axis
- Option 30HVC: Shuttle changer



#### Shuttle

Tool magazine with shuttle  
(standard for 50HVC)

- For HSK63 with 60 tool places  
(option for 30HVC)
- For HSK100 with 40 tool places
- Travelling in X- and Y-axis
- Tool change in each X-position

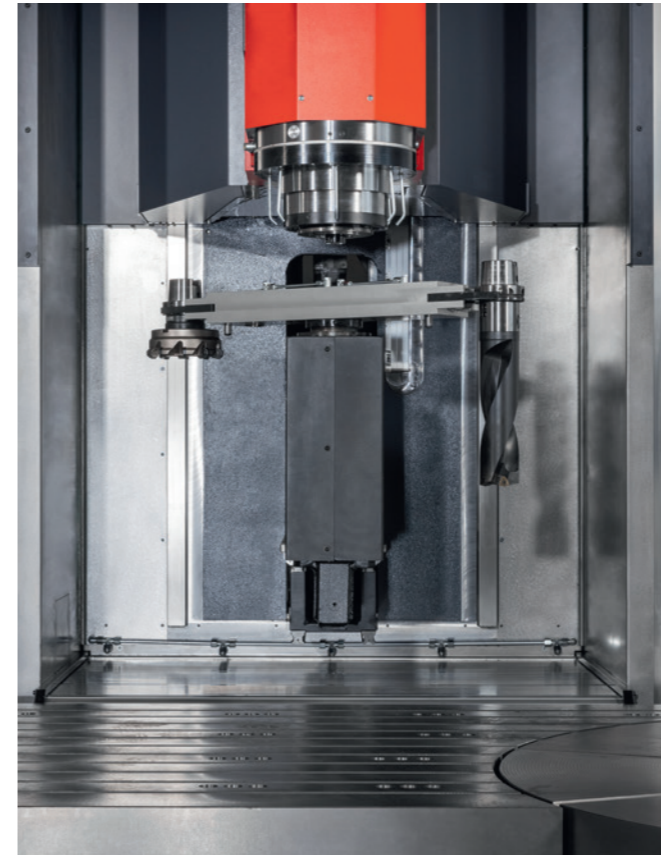

#### Additional magazine

Extension of the tool capacity to the magazine in the machine (option):

- To 220 tool places in performance class HSK63 | SK40
- To 132 tool places in performance class HSK100
- To 112 tool places in performance class SK50
- Larger magazines can be made available on request



## Technical data standard series HVC Performance class HSK 63 | SK40

Work area	Unit	MATEC 30HVC							
X-axis	mm	1,300	1,500	3,000	3,000	3,000	4,000	4,000	4,000
Y-axis	mm	600	825	825	1,125	1,125	825	1,125	1,125
Z-axis	mm	800	1,100	1,100	1,100	1,300	1,100	1,100	1,300
Distance spindle nose   machine table (vertical)	mm	675	975	975	980	1,180	975	980	1,180
Distance spindle centre   machine table (horizontal)	mm	175	175	175	180	180	175	180	180
<b>1-Axis swivel head</b>									
Swivel radius	mm	300							
Swivel angle	Degrees	+/- 105							
Direct path measuring system	sec.	+/- 3"							
Torque clamped   unclamped	Nm	4,200   2,400							
<b>Main spindle (standard)   Motor spindles available in other performance classes as an option (see page 52 - 53)</b>									
Tool holder		HSK 63   SK40*							
Speed	1/min.	9,000							
Power at 25   40   100 % DC	kW	19   16   11							
Torque at 25   40   100 % DC	Nm	115   100   75							
<b>Tool magazine (travelling)</b>									
Tool places	pcs.	48   60 **   80 **							
Tool places with auxiliary magazine max.	pcs.	280 (can be extended according to customer requirements) **							
Tool length	mm	340   450							
Tool Ø (all places occupied)	mm	70							
Tool Ø (secondary places free)	mm	140   200*							
Tool weight max.	kg	10							
<b>Tool changer (travelling)</b>									
Changing system		Double gripper							
Tool change position		in every X- and Y- position							
<b>Axis drives</b>									
Ball screw drive (standard)		Ball screw drive							
Rapid traverse   Feed rate	m/min.	48 (up to Y = 825 mm)   30 (with Y = 1,125 mm)							
<b>Machine table</b>									
Table length	mm	1,515	1,700	3,500	3,500	3,500	4,500	4,500	4,500
Table width Y-825   1,025   1,125	mm	635	835	835	1,155	1,155	835	1,155	1,155
T-slots according to DIN 650	mm	18 <sup>H7</sup>							
Number of T-slots with Y=600   825   1,125 mm	pcs.	5	7	7	11	11	7	11	11
Slot spacing for Y= 600   825   1,125 mm	mm	125	125	125	100	100	125	100	100
Table load max. (dowelled)	kg   m <sup>2</sup>	500	1,000	1,000	1,500	1,500	1,000	1,500	1,500
<b>CNC rotary table</b>									
Faceplate (integrated) Ø	mm	630	800	800	1,150	1,150	800	1,150	1,150
Drive type (positioning axis)		Worm drive							
Speed max.	1/min.	25	25	25	6.25	6.25	25	6.25	6.25
Table load (centric) max.	kg	1,000	1,500	1,500	2,000	2,000	1,500	2,000	2,000
Torque, unclamped	Nm	3,000							
Torque, clamped	Nm	7,000							
Direct path measuring system	arc sec.	+/- 5"							

\* Option

\*\* Tool change with shuttle (option)

## Technical data standard series HVC Performance class HSK 100 | SK50

Work area	Unit	40HVC	40HVC and 50HVC					
X-axis	mm	1,500	3,000	3,000	3,000	4,000	4,000	4,000
Y-axis	mm	825	825	1,125	1,125	825	1,125	1,125
Z-axis	mm	1,100	1,100	1,100	1,300	1,100	1,100	1,300
Distance spindle nose   machine table (vertical)	mm	990	990	1,000	1,200	990	1,000	1,200
Distance spindle centre   machine table (horizontal)	mm	250	250	260	260	250	260	260
<b>1-Axis swivel head</b>		<b>40HVC</b>	<b>40HVC</b>			<b>50HVC</b>		
Swivel radius	mm	360			350			
Swivel angle	Degrees	+/- 105						
Direct path measuring system	sec.	+/- 3"						
Torque clamped   unclamped	Nm	4,200   2,400						
<b>Main spindle (standard)   Motor spindles available in other performance classes as an option (see page 52 - 53)</b>								
Tool holder		HSK100   SK50*						
Speed	1/min.	8,000						
Power at 25   40   100 % DC	kW	42   37   25						
Torque at 25   40   100 % DC	Nm	265   235   150						
<b>Tool magazine (travelling)</b>								
Tool places	pcs.	40			40   60			
Tool places with auxiliary magazine max.	pcs.	172 (can be extended according to customer requirements)			172   192			
Tool length	mm	450 (with HSK 100)   430 with SK50						
Tool Ø (all places occupied)	mm	104						
Tool Ø (secondary places free)	mm	200						
Tool weight max.	kg	20						
<b>Tool changer (travelling)</b>								
Changing system standard		Double gripper			Shuttle			
Tool change position		above the workpiece			Rear Y-axis			
<b>Axis drives</b>								
Ball screw drive (standard)		Ball screw drive						
Rapid traverse   Feed rate	m/min.	48 (with Y = 825 mm)   30 (with Y = 1,125 mm)						
<b>Machine table</b>		<b>40HVC</b>	<b>40HVC and 50HVC</b>					
Table length	mm	1,700	3,500	3,500	3,500	4,500	4,500	4,500
Table width	mm	835	835	1,155	1,155	835	1,155	1,155
T-slots according to DIN 650	mm	18 <sup>H7</sup>						
Number of T-slots for Y-825   1,125 mm	pcs.	7	7	11	11	7	11	11
Slot spacing for Y-825   1,125 mm	mm	125	125	100	100	125	100	100
Table load max.	kg   m <sup>2</sup>	1,000	1,000	1,500	1,500	1,000	1,500	1,500
<b>CNC rotary table</b>								
Faceplate (integrated) Ø	mm	800	800	1,150	1,150	800	1,150	1,150
Drive type (positioning axis)		Worm drive						
Speed max.	1/min.	25	25	6.25	6.25	25	6.25	6.25
Table load max.	kg	1,500	1,500	2,000	2,000	1,500	2,000	2,000
Torque, unclamped	Nm	3,000						
Torque, clamped	Nm	7,000						
Direct path measuring system	arc sec.	+/- 5"						

\* Option

\*\* Tool change with shuttle (option)

## MATEC 30SHV

### Machining centre with swivel head and swivel table

Loading and unloading during machining  
Pallet change in approx. 4 seconds



Moving column machining centre with swivel head, designed for medium and large series production. The basic machine is the MATEC 30HV with an X-travel of 2,000 mm. The production principle of the MATEC 30SHV is based on a 0-180° pendulum swivel table with two work areas. The work area is changed by a 180° rotation of the swivel table.

A lifting door with safety glass separates the machining chambers. This design enables loading and unloading to take place during machining while the machine is producing in the other work area. Unproductive non-productive time is thus reduced to a minimum.

Accessibility and visual control for the machine operator are optimal. The same applies to automated loading and unloading.

The modular design of the basic machine and swivel table from the modular system creates the perfect individual solution. In conjunction with the swivel head, long work-pieces can also be machined at both ends. Additional machining units, oversized tools and special equipment can also be set up economically via pick-up stations. Rotary distributors for clamping hydraulics, pneumatics or vacuum integrated in the swivel table enable complex fixtures with different clamping sequences.

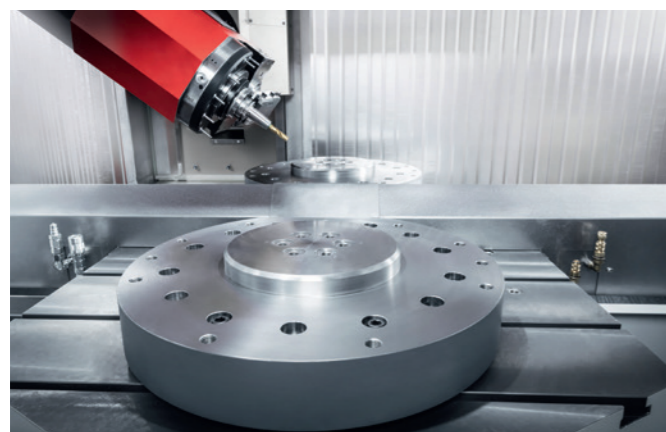
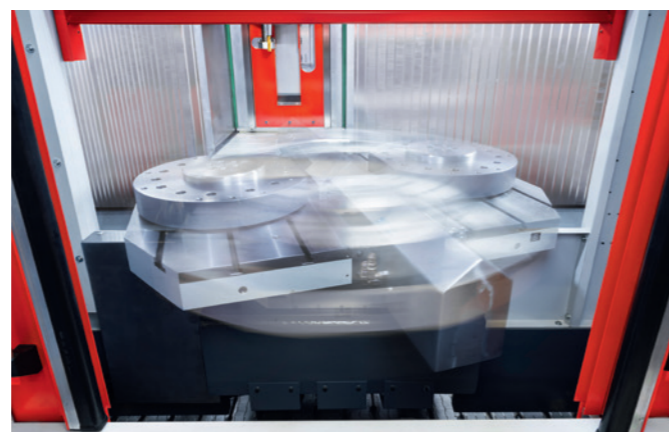

Illustration of the two work areas with open safety partition wall.



Swivel table 0-180° in pendulum movement.

## Technical data

Work area	Dim.	MATEC 30SHV
X-axis	mm	2,000
Y-axis	mm	600
Z-axis	mm	800
Distance spindle nose   machine table (vertical)	mm	675
Distance spindle centre   machine table (horizontal)	mm	175
<b>1-Axis swivel head</b>		
Swivel radius	mm	300
Swivel angle	Degrees	±105
Direct path measuring system	sec.	±3"
Torque clamped   unclamped	Nm	4,000   2,200
<b>Main spindle (standard)   Motor spindles available in other performance classes as an option (see page 52 - 53)</b>		
Tool holder		HSK63
Speed	1/min	9,000
Power at 20   40   100% DC	kW	19   16   11
Torque 20   40   100% DC	Nm	115   100   75
<b>Tool magazine (travelling)</b>		
Tool places	pcs.	48
Tool length	mm	340
Tool Ø all places occupied	mm	70
Tool Ø secondary places free	mm	140
Tool weight	kg	3   10
<b>Axis drives</b>		
Ball screw drive (standard)		
Rapid traverse	m/min	48
Feed rate	mm/min	30,000
<b>Swivel table</b>		
Table width	mm	850
Table depth	mm	550
T-slots according to DIN 650	mm	14H8
Number of T-slots per table side	pcs.	3
Slot spacing	mm	160
Table load max.	kg	2 x 400
Swivel time approx.	sec.	4 (depending on weight)



Infinitely variable swivel head for multi-sided or end machining.

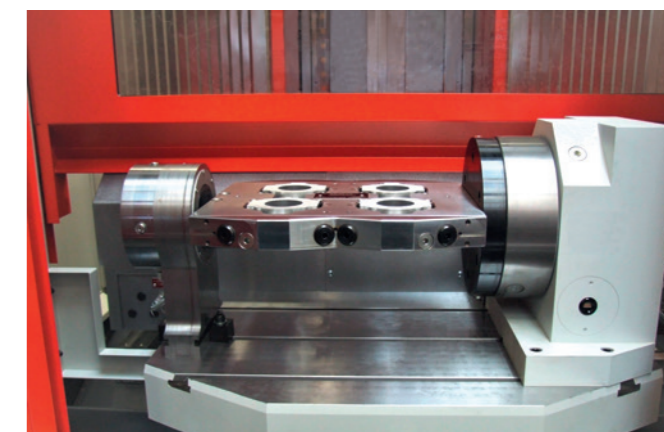

Work area 1: Set-up with rotary table, fixture bridge and counter bearing. Multi-side machining.

MATEC 30HV | 40HV | 50HV | 60 HV | 70 HV  
 Modular group HV  
 Basic machines



Thanks to the modular design and a variety of options, MATEC centres can be tailored to almost any machining task. Thanks to our individual solutions for more economic efficiency, you will be ahead of the market and gain a crucial competitive edge!

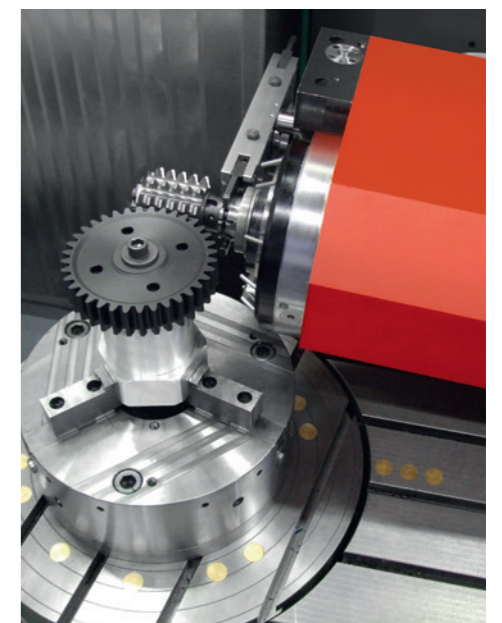
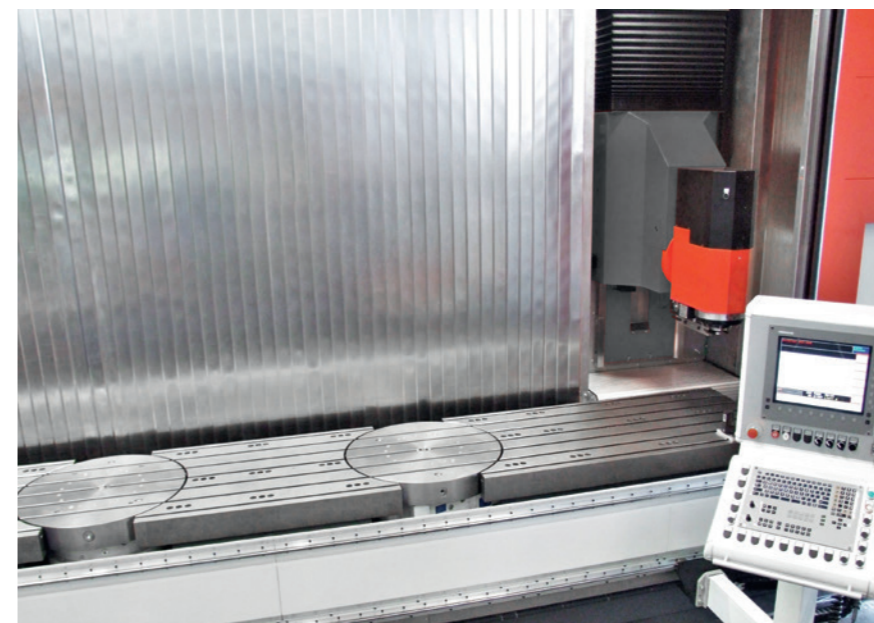
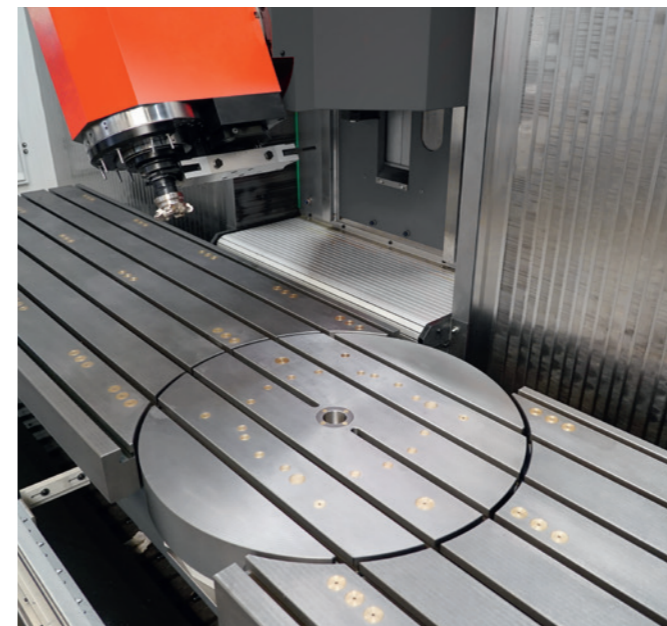
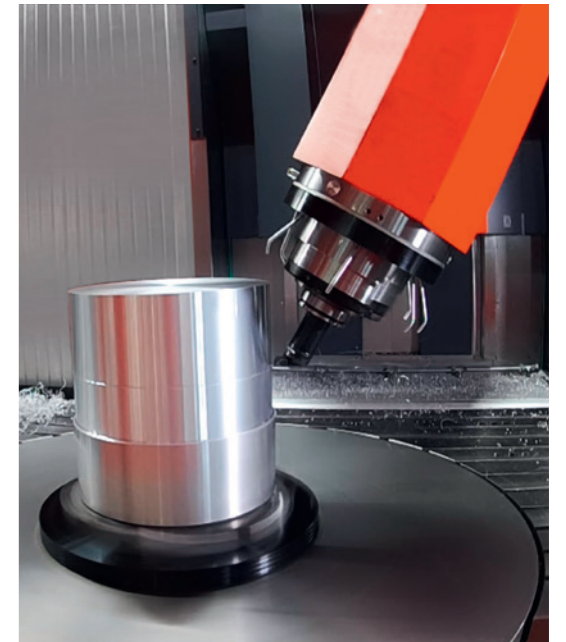
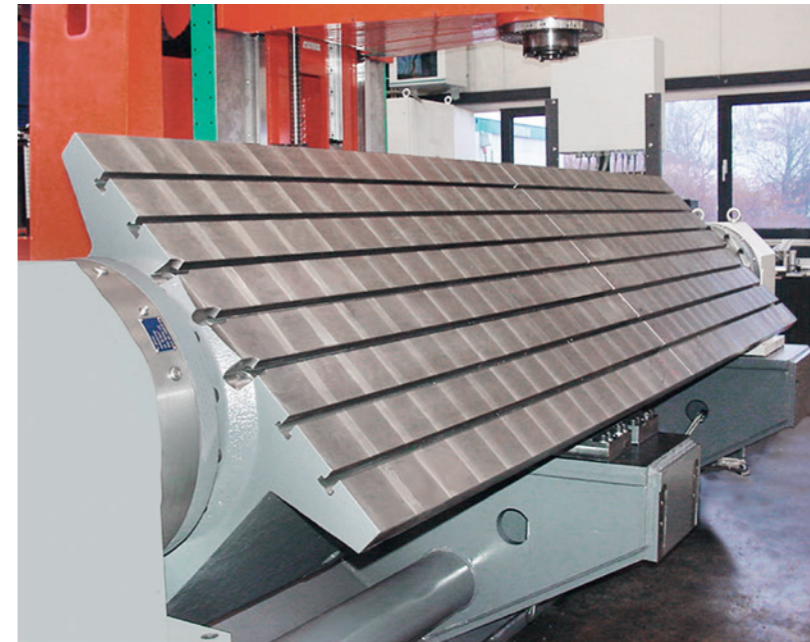

MATEC 30HV | 40HV | 50HV | 60 HV | 70HV  
 Modular group HV  
 Basic machines



**Basic requirements for MATEC machining centres**

Our main focus is not on achieving individual maximum values in comparison tables, but on the perfect coordination of all machine components with each other. Only the optimal interaction enables the transmission of the full spindle power and thus guarantees a safe machining process.

The basis of all MATEC centres is, therefore, absolute stability. Only this guarantees optimum machining conditions and, last but not least, highly precise workpieces.

Basic versions of the machine table assembly group

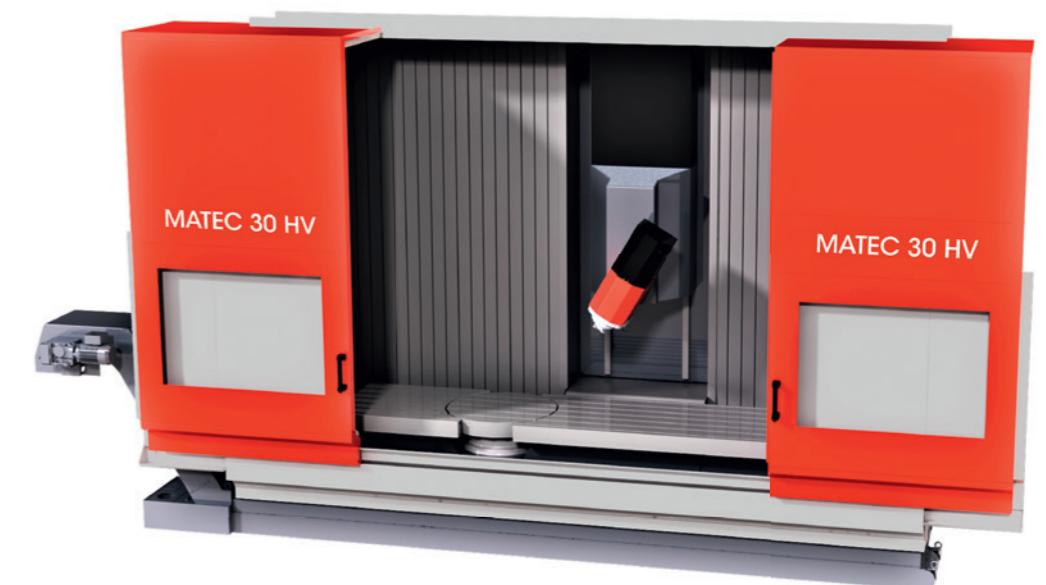

Standard machine table



Integrated rotary table



Oversized rotary table

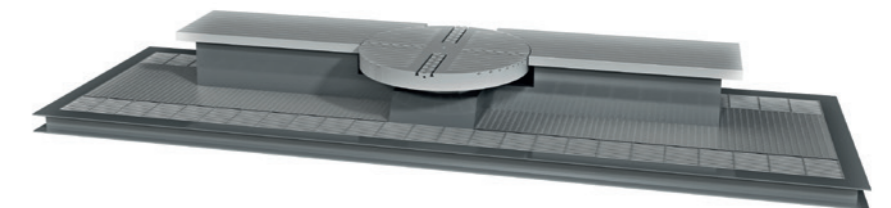

**Swivelling machine table in bridge design.**

Full-length or divided version.  
 The use of a partition wall creates two separate work areas.

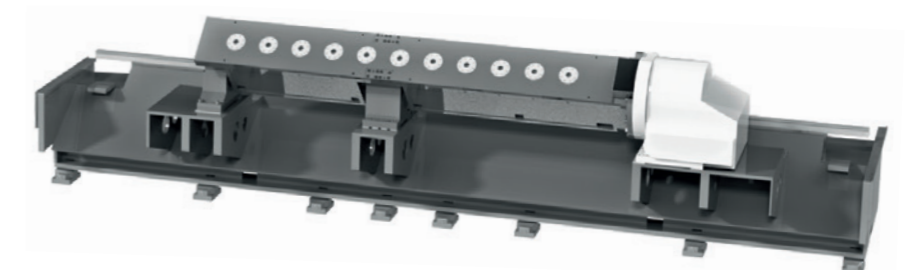

## MATEC 30HV | 60HV

### Modular group HV

Standard equipment – machines and options

Performance class HSK63 | SK40

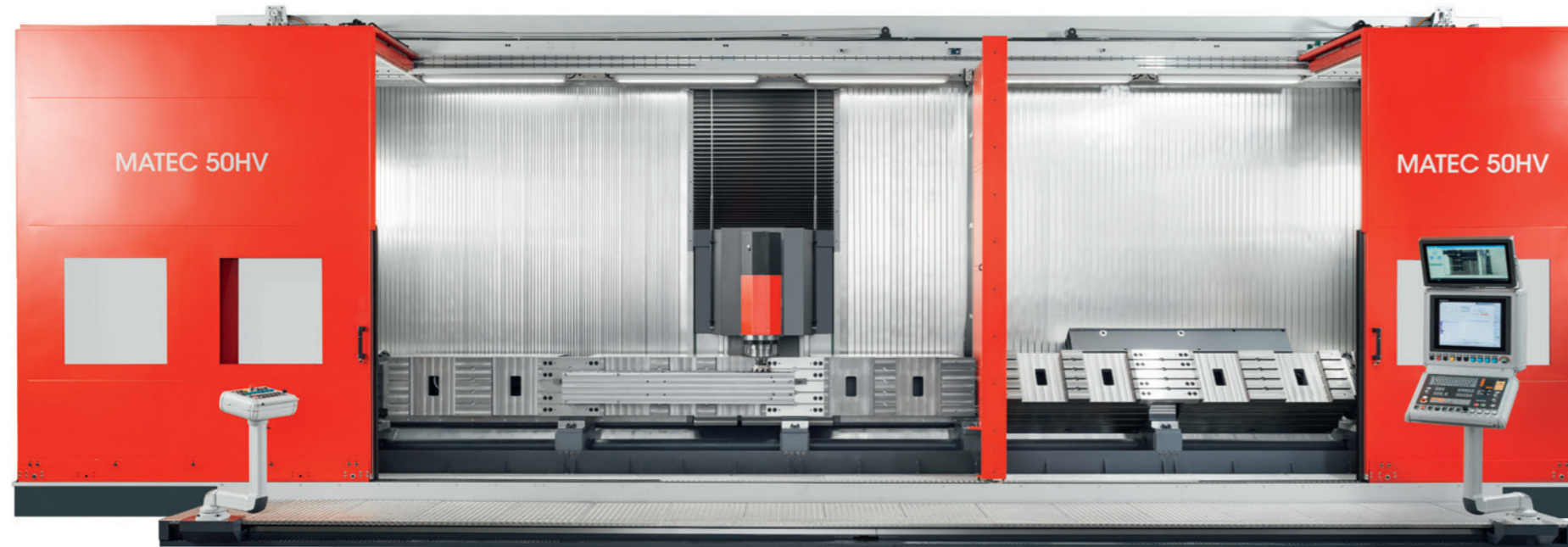

#### Standard equipment

- 1-Axis CNC swivel head, infinitely variable
- CNC control Heidenhain TNC 640
- Speed: 9,000 1/min
- Motor spindle: Drive power max. 19 kW
- Torque: max. 120 Nm
- Tool holder HSK63
- 30HV tool change with double gripper, 48 tool places
- 60HV tool change with shuttle, 60 tool places
- Axis drives with ball screw drive
- Roller linear guides in all axes
- Direct path measuring systems
- Standard machine table with T-slots

- Full work area enclosure with roof
- Chip conveyor
- Coolant unit

#### Options for the basic machine

##### Swivel head

- Dynamic CNC swivel head with direct drive

##### Motor spindle

- Higher power motor spindle
  - Speed range: 12,000 to 42,000 1/min
  - Power: up to max. 159 kW
  - Torque: up to max. 230 Nm

- Tool holder SK40

##### Drive system

- X-axis with linear drive
- X-axis with rack and pinion drive

#### Options independent of the performance class

##### Machine table assembly group

- Customised machine table assembly group
- Integrated or top-mounted rotary tables, position freely selectable
- CNC rotary tables for positioning and turning
- Other table heights

- Adaptation of T-slots to customer's existing fixtures and clamping systems
- Zero-point clamping systems according to customer requirements
- Swivelling machine tables according to the customer's requirement profile.
- Tool changing system with shuttle from Y-axis 825 mm and Z-axis 1,100 mm

## MATEC 40HV | 50HV | 70 HV

### Modular group HV

Standard equipment – machines and options

Performance class HSK100 | SK50



#### Standard equipment

- 1-Axis CNC swivel head, infinitely variable
- CNC control Heidenhain TNC 640
- Speed: 8,000 1/min
- Motor spindle: Drive power max. 37 kW
- Torque: max. 306 Nm
- Tool holder HSK100
- 40HV tool change with double gripper, 40 tool places
- 50HV and 70HV tool change with shuttle, 60 tool places
- Axis drives with ball screw drive
- Roller linear guides in all axes
- Direct path measuring systems
- Standard machine table with T-slots

- Full work area enclosure with roof
- Chip conveyor
- Coolant unit

#### Options for the basic machine

##### Swivel head

- Fast CNC swivel head with direct drive

##### Motor spindle

- Higher power motor spindle
  - Speed range: 10,000 | 15,000 1/min.
  - Power: up to max. 96 kW
  - Torque: up to max. 1,000 Nm

- Tool holder SK50

##### Drive system

- X-axis with linear drive
- X-axis with rack and pinion drive

- Partition wall for pendulum machining, fixed or variable position
- Automatic work area doors

#### Tool magazines / capacity extensions

- Additional magazines, pick-up magazines

#### Automation and special equipment

- Mill turn with automatic balancing in the machine

- Sawing units, multi-spindle and angle heads
- Deep hole drilling
- Workpiece machining from bar (bar feeder)
- Loading automation, pallet change
- Friction stir welding (FSW)

## Modular group HV

### Our strength: flexible set-up and clamping systems

#### For both performance classes



#### Multi-side machining

- Rotary table and counter bearing, positionable via CNC axis
- Quick-change system with rotary feed-through
- Control of hydraulics, pneumatics, electrics and vacuum
- Swivel bridges and fixtures, also for direct clamping of workpieces in different lengths

#### Mill turn centre: Variants and combinations

- Motor spindle with integrated clamping
- Additional tool holder for heavily interrupted cuts during turning
- One or two rotary tables for pendulum machining
- Rotary tables integrated in the machine table or free-standing
- Rotary tables with direct drive up to 1,000 1/min.
- Faceplates from  $\text{Ø } 630$  to  $3,000$  mm
- Rotary spindles up to  $6,000$  1/min.
- Option "grinding" possible

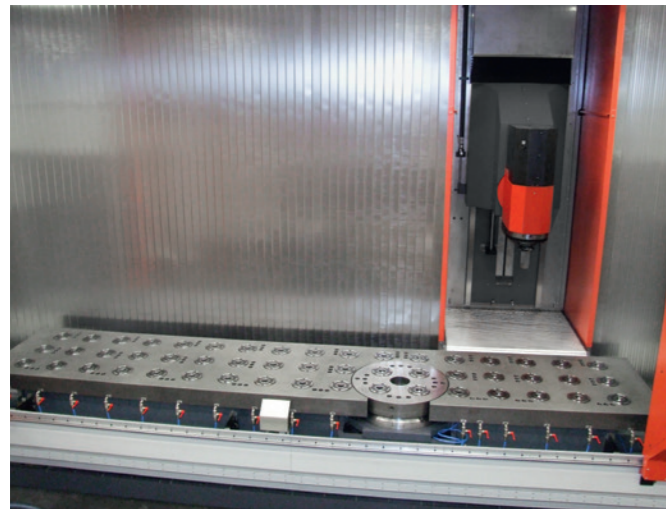

#### Maximum flexibility

- Machine table and CNC rotary table with integrated zero-point clamping systems. Perfect fixture and workpiece clamping in different applications
- The make of the zero point clamping system and the arrangement of the clamping elements (grid) are freely selectable

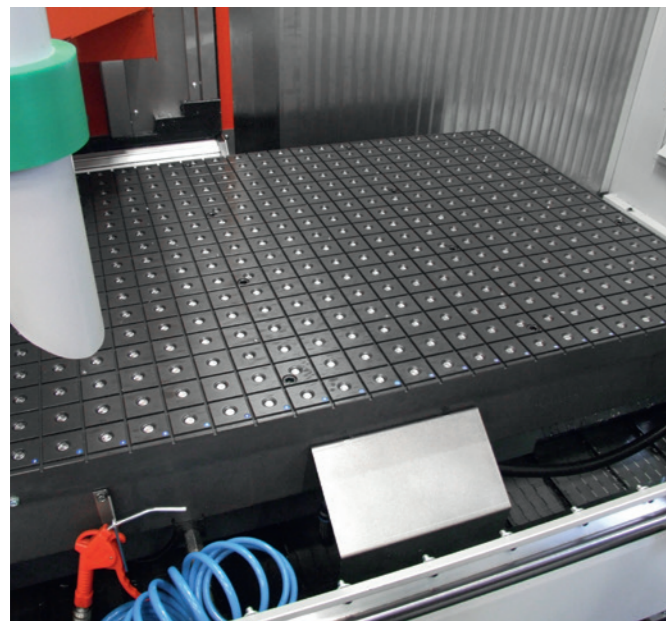

#### Clamping systems for large workpieces

- Magnetic or vacuum clamping
- Movable suction unit
- Complete solutions from one source

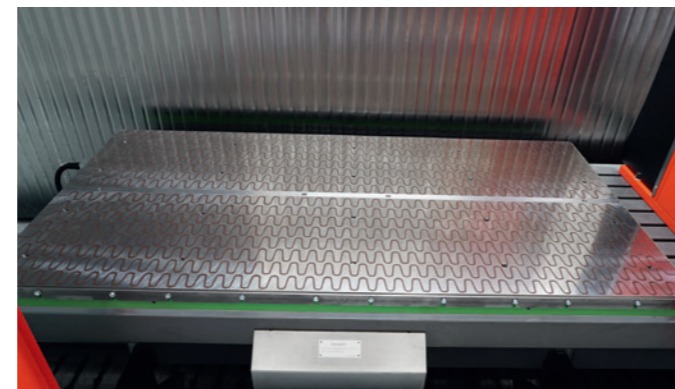

#### Production of various gears

- Gear hobbing, straight or helical, including shifting
- Skiving, internal and external
- Gear cutting, internal and external



## Modular group HV Swivel bridge machines

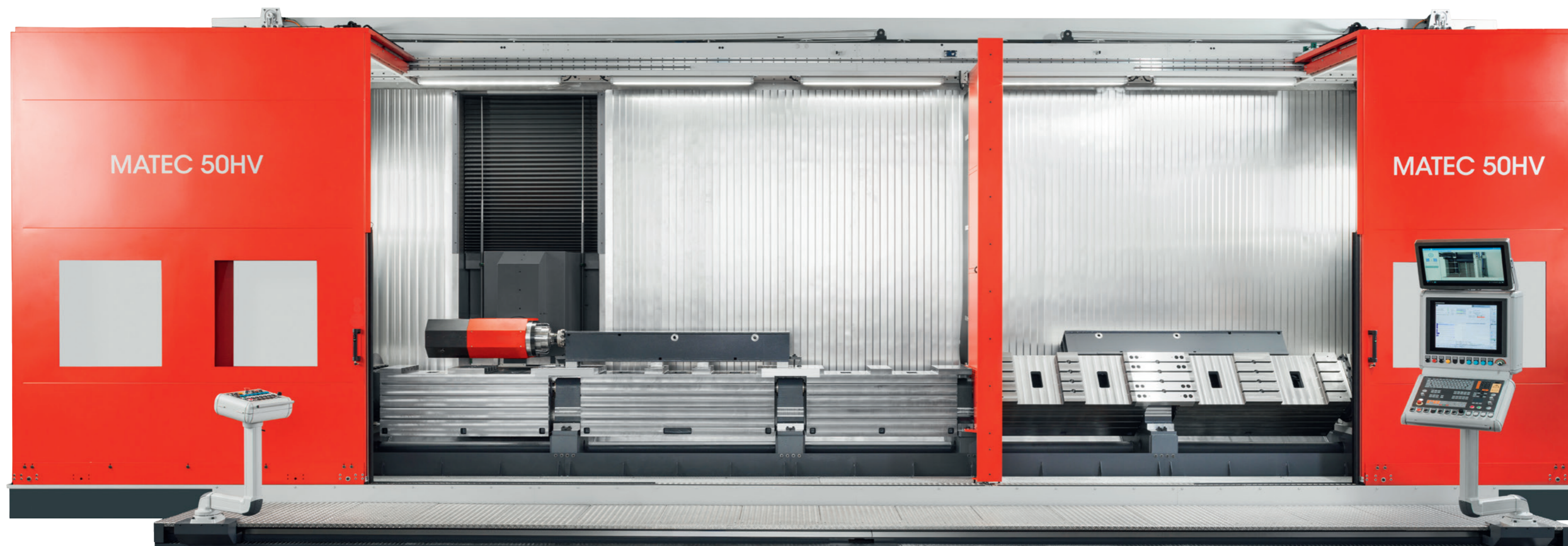

### Machine design (Fig. above)

- Machine with asymmetrical work area
- Swivel bridge 5,000 mm and 3,000 mm
- Pendulum operation
- Long bed swivel bridge operation 8,000 mm

### Pioneering production concept

Optionally applicable for all MATEC long bed machines. With individually configurable swivel bridges, a universal production solution is created that is precisely tailored to the user and offers the highest savings potential.

### Possible applications:

- Bending and folding tools
- Industrial knives
- Foil tools
- Profiles etc.

### Swivel bridges

- One- to four-sided
- Width and swivel circle depending on Y- and Z-axis
- Table widths up to 1,600 mm
- Special solutions can be made available on request



## Modular group HV

### Technical data performance class HSK63 | SK40

Work area	Unit	30HV	60HV
X-axis	mm	1,300 - 12,000	3,400 - 12,500
Y-axis	mm	600   825   1,025   1,125   1,225	1,630
Z-axis	mm	800   1,100   1,300	1,350   1,850
Distance spindle nose   machine table (vertical)	mm	675 - 1,240	1,250   1,750
Distance spindle centre   machine table (horizontal)	mm	175 - 240	250
<b>1-Axis swivel head</b>			
Swivel radius	mm	300	
Swivel angle	Degrees	+/- 105	
Direct path measuring system	sec.	+/- 3"	
Torque clamped   unclamped	Nm	4,200   2,400	
<b>Main spindle (standard)   Motor spindles available in other performance classes as an option (see page 52 - 53)</b>			
Tool holder		HSK 63   SK40*	
Speed	1/min.	9,000 - 42,000	
Power max.	kW	19 - 159	
Torque max.	Nm	120 - 230	
<b>Tool magazine (travelling)</b>			
Tool places (main magazine)	pcs.	48 - 80	60 - 80
Tool places with auxiliary magazine max.		300	300
Tool length	mm	340   450	450
Tool Ø (all places occupied)	mm	70	70
Tool Ø (secondary places free)	mm	140   200*	200
Tool weight max.	kg	10	10
<b>Tool changer (travelling)</b>			
Changing system standard		Double gripper	Shuttle
Tool change position		in every X-/Y-position	in every X-position   Y-position: 0
<b>Axis drives</b>			
<b>Ball screw drive (standard)</b>			
		Ball screw drive	
Rapid traverse   Feed rate (depending on Y-travel)	m/min.	48 (up to Y = 1,025 mm)   30 (Y > 1,025 mm)	30
<b>Linear drive (up to Y = 825 mm)*</b>			
Rapid traverse   Feed rate Y-600   825	m/min.	100   80	-
<b>Rack and pinion drive (from Y = 1,025 mm)*</b>			
Rapid traverse   Feed rate	m/min.	48	48
<b>Machine table</b>			
Table length	mm	Travel X-axis + 500	
Table width with Y-600   825   1,025   1,125   1,225	mm	635   835   1,035   1,155   1,235	1,700
T-slots according to DIN 650		18 <sup>H7</sup>	
Number of T-slots for Y-600   825   1,025   1,125   1,225 mm	pcs.	5   7   9   11   11	13
T-slot spacing for Y-600   825   1,025   1,125   1,225 mm	mm	125   125   100   100   100	125
Table load max.	kg   m <sup>2</sup>	500   1,000   1,000   1,500   1,500	2,500
<b>Accuracies</b>			
Positioning accuracy up to 2,000 mm	mm	0.01	
Repeatability (absolute)	mm	0.003	
Positioning tolerance DIN/ISO 230-2	mm	0.004	

\* Option

## Technical data performance class HSK100 | SK50

Work area	Unit	40HV	50HV	70HV
X-axis	mm	1,500 - 12,000	2,000 - 12,000	3,400 - 12,500
Y-axis	mm	825   1,025   1,125   1,225		1,630
Z-axis	mm	800   1,100   1,300	1,100   1,300	1,350   1,850
Distance spindle nose   machine table (vertical)	mm	690 - 1,200	990 - 1,200	1,250   1,750
Distance spindle centre   machine table (horizontal)	mm	250   260	250   260	250
<b>1-Axis swivel head</b>				
Swivel radius	mm	360	350	
Swivel angle	Degrees	+/- 105		
Direct path measuring system	sec.	+/- 3"		
Torque clamped   unclamped	Nm	4,200   2,400		
<b>Main spindle (standard)   Motor spindles available in other performance classes as an option (see page 52 - 53)</b>				
Tool holder		HSK100   SK50 *		
Speed	1/min.	8,000 - 15,000		
Power max.	kW	37 - 84	37 - 96	
Torque max.	Nm	306 - 575	306 - 690	
<b>Tool magazine (travelling)</b>				
Tool places (main magazine)	pcs.	40	40   60	
Tool places with auxiliary magazine max.		176	196	
Tool length	mm	340   460	460	
Tool Ø (all places occupied)	mm	104		
Tool Ø (secondary places free)	mm	200		
Tool weight max.	kg	20		
<b>Tool changer (travelling)</b>				
Changing system standard		Double gripper	Shuttle	
Tool change position		in every X-   Y-position	in any X-position   Y-position: 0	
<b>Axis drives</b>				
<b>Ball screw drive (standard)</b>				
		Ball screw drive		
Rapid traverse   Feed rate (depending on Y-travel)	m/min.	48 (up to Y = 1,025 mm)   30 (Y > 1,025 mm)		30
<b>Linear drive (up to Y = 825 mm)*</b>				
Rapid traverse   Feed rate Y-825	m/min.	80	80	-
<b>Rack and pinion drive (from Y = 1,025 mm)*</b>				
Rapid traverse   Feed rate	m/min.	48	48	48
<b>Machine table</b>				
Table length	mm	Travel X-axis + 500		
Table width with Y-825   1,025   1,125   1,225 mm	mm	835   1,035   1,155   1,235	1,700	
T-slots according to DIN 650		18 <sup>H7</sup>		
Number of T-slots for Y-825   1,025   1,125   1,225 mm	pcs.	7   9   11   11	13	
Distance between slots for Y-825   1,025   1,125   1,225 mm	mm	125   100   100   100	125	
Table load max.	kg   m <sup>2</sup>	1,000   1,000   1,500   1,500	2,500	
<b>Accuracies</b>				
Positioning accuracy up to 2,000 mm	mm	0.01		
Repeatability (absolute)	mm	0.003		
Positioning tolerance DIN/ISO 230-2	mm	0.004		

\* Option



MATEC 30HVU | 30U | 50HVU | 50U | 60HVU | 60U | 70HVU | 70U  
 Modular group HVU | U  
 Basic machines

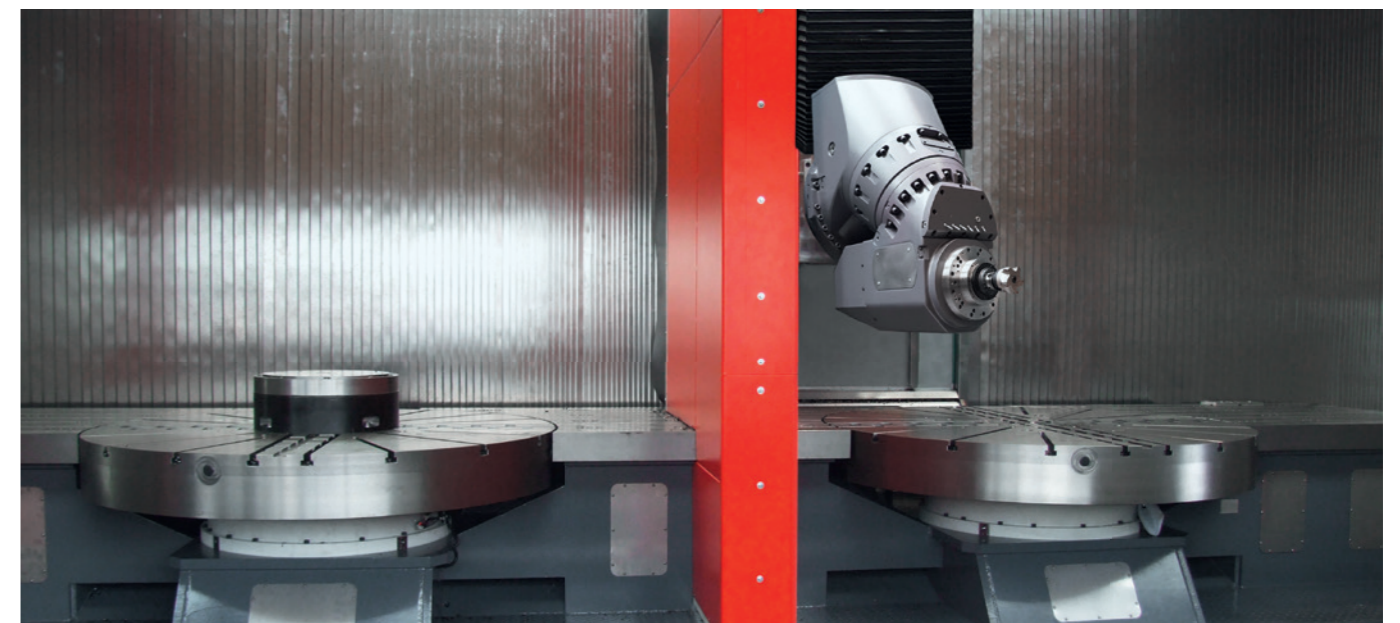

Those who rely on individual solutions from MATEC successfully differentiate themselves on the market.

We develop modern and innovative machining centres that also meet the future requirements of our customers. Thanks to the modular design with a variety of options and accessories, we adapt each centre individually to your machining task. In this way, you achieve high added value and open up new business areas and markets.

Modular group HVU | U  
 2-Axis universal head HVU | 1-Axis universal head U  
 Performance class HSK63 | HSK100



Basic versions of the machine table assembly group



Standard fixed table

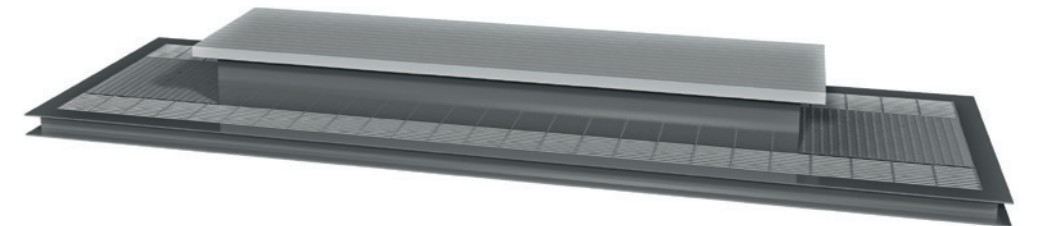

Machine table assembly group with fixed table and large rotary table

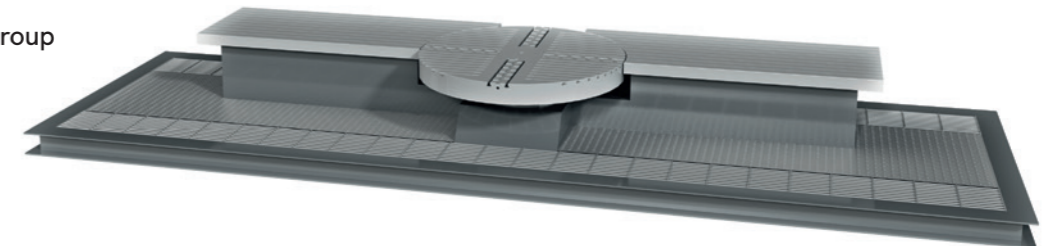

Fixed table with two large rotary tables  
 With partition wall, production in pendulum process is possible.

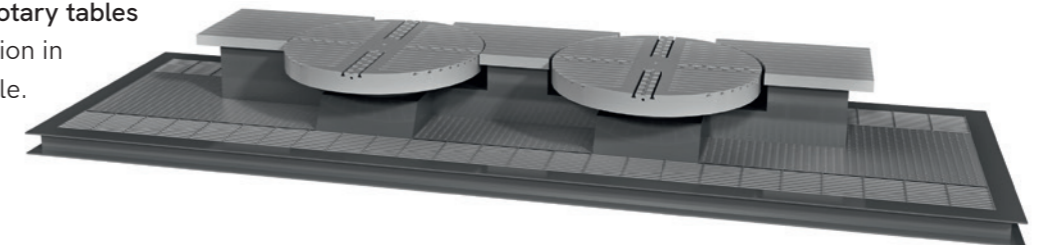

W-axis with large rotary table  
 Available as pallet changer as an option.

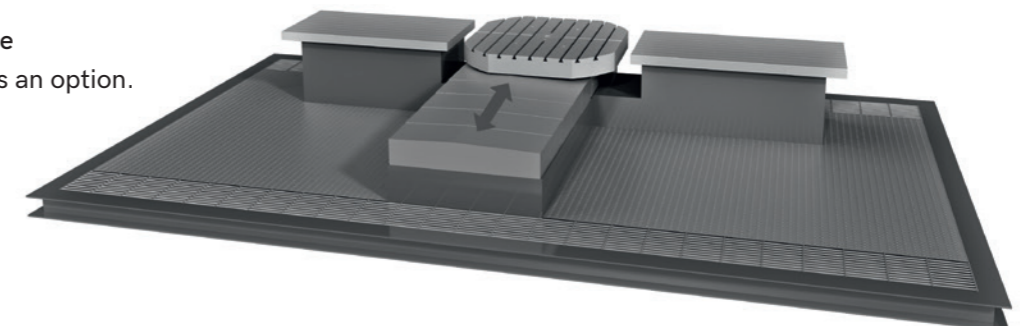

## MATEC 30HVU | 30U | 60HVU | 60U

### Modular group HVU | U

#### Standard equipment – machines and options

#### Performance class HSK63 | SK40

##### Standard equipment

- 2-Axis universal head, infinitely variable (HVU)
- 1-Axis universal head, infinitely variable (U)
- CNC control Heidenhain TNC 640
- Speed: 9,000 1/min
- Motor spindle: Drive power max. 19 kW
- Torque: max. 120 Nm
- Tool holder HSK63
- Tool change with shuttle, 48 tool places
- Axis drives with ball screw drive
- Roller linear guides in all axes
- Direct path measuring systems
- Standard machine table with T-slots
- Full work area enclosure with roof
- Chip conveyor
- Coolant unit

##### Options for the basic machine

###### Motor spindle

- Higher power motor spindle
  - Speed range: 12,000 to 42,000 1/min
  - Power: up to max. 159 kW
  - Torque: up to max. 280 Nm
- Tool holder SK40

###### Tool magazine

- Extension from 48 to 280 tool places
- Drive system:
  - X-axis with linear drive
  - X-axis with rack and pinion drive



## MATEC 50HVU | 50U | 70HVU | 70U

### Modular group HVU | U

#### Standard equipment – machines and options

#### Performance class HSK100 | SK50

##### Standard equipment

- 2-Axis universal head, infinitely variable (HVU)
- 1-Axis universal head, infinitely variable (U)
- CNC control Heidenhain TNC 640
- Speed: 8,000 1/min
- Motor spindle: Drive power max. 37 kW
- Torque: 306 Nm
- Tool holder HSK100
- Tool change with shuttle, 40 tool places
- Axis drives with ball screw drive
- Roller linear guides in all axes
- Direct path measuring systems
- Standard machine table with T-slots
- Full work area enclosure with roof
- Chip conveyor
- Coolant unit

##### Options for the basic machine

###### Motor spindle

- Higher power motor spindle
  - Speed range: 10,000 to 15,000 1/min.
  - Power: up to max. 96 kW
  - Torque: up to max. 1,000 Nm
- Tool holder SK40

###### Tool magazine

- Extension from 48 to 280 tool places
- Drive system:
  - X-axis with linear drive
  - X-axis with rack and pinion drive

##### Options independent of the performance class

###### Machine table assembly group

- Customised machine table assembly group
- CNC slide unit as W-axis for larger swivel circles
- Integrated or top-mounted rotary tables, position freely selectable
- CNC rotary tables for positioning and turning

- Other table heights
- Adaptation of T-slots to customer's existing fixtures and clamping systems
- Zero-point clamping systems according to customer requirements
- Swivelling machine tables according to the customer's requirement profile

- Partition wall for pendulum machining, fixed or variable position
- Automatic work area doors

###### Tool magazines | capacity extensions

- Additional magazines, pick-up magazines, automation and special equipment

- Mill turn with automatic balancing in the machine
- Multi-spindle and angle heads
- Deep hole drilling
- Loading automation, pallet change

## Modular group HVU | U Standardised solutions in both performance classes

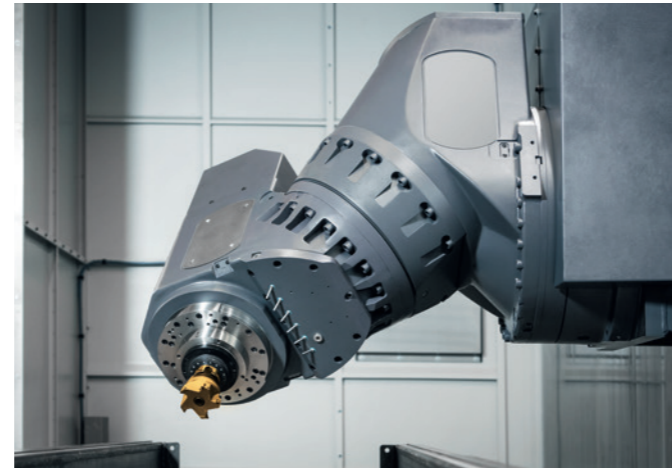
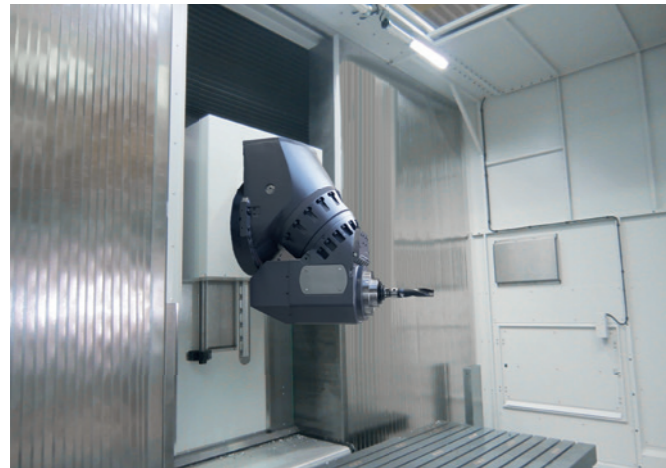

### MATEC U

Infinitely variable 1-axis universal head

- 45° swivel axis
- For machining on long parts
- With optional rotary table for 5-axis simultaneous machining

### MATEC HVU

Infinitely variable 2-axis universal head

- 180° | 45° swivel axis
- For machining on long parts
- With optional rotary table for 5-axis simultaneous machining

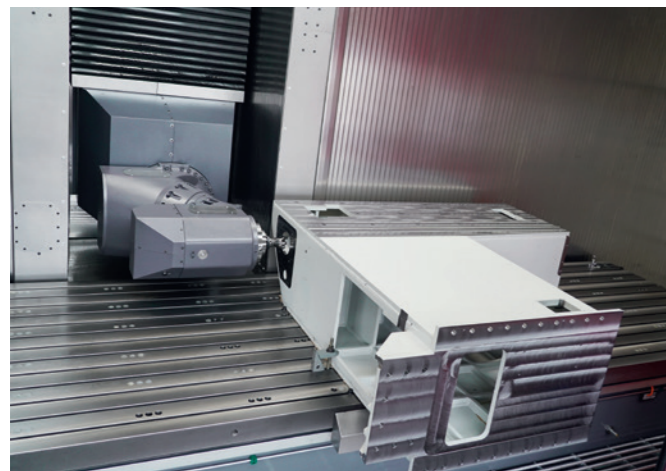

### MATEC HVU

#### Work area

- Optimal ergonomics
- Walk-in work area
- Full enclosure with roof
- Version with 2 chip conveyors
- Standard machine table
- Top-mounted rotary table with vertical faceplate for peripheral machining of workpieces



### MATEC 60HVU | 70HVU

Multi-sided machining in large-scale production, castings, welded constructions, vehicle axles, bogies, rings, shafts and tubes

- X-axis up to 10,400 mm with full enclosure (other lengths can be made available on request)
- Y-axis 1,630 mm
- Z-axis up to 1,850 | 2,380 mm
- Expandable to a mill turn centre up to 3,200 mm workpiece diameter

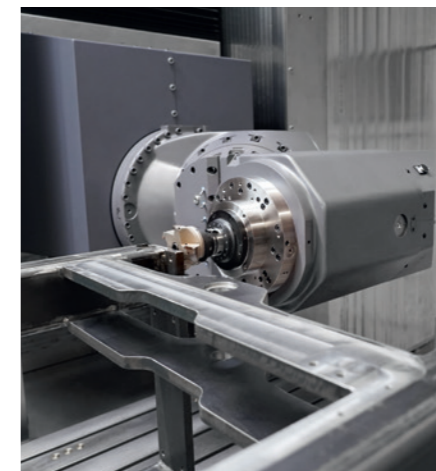

### MATEC HVU

2-Axis universal head



Infinitely variable in space:  
Discover the limitless possibilities  
of our 2-axis universal head.

## Application examples HVU group

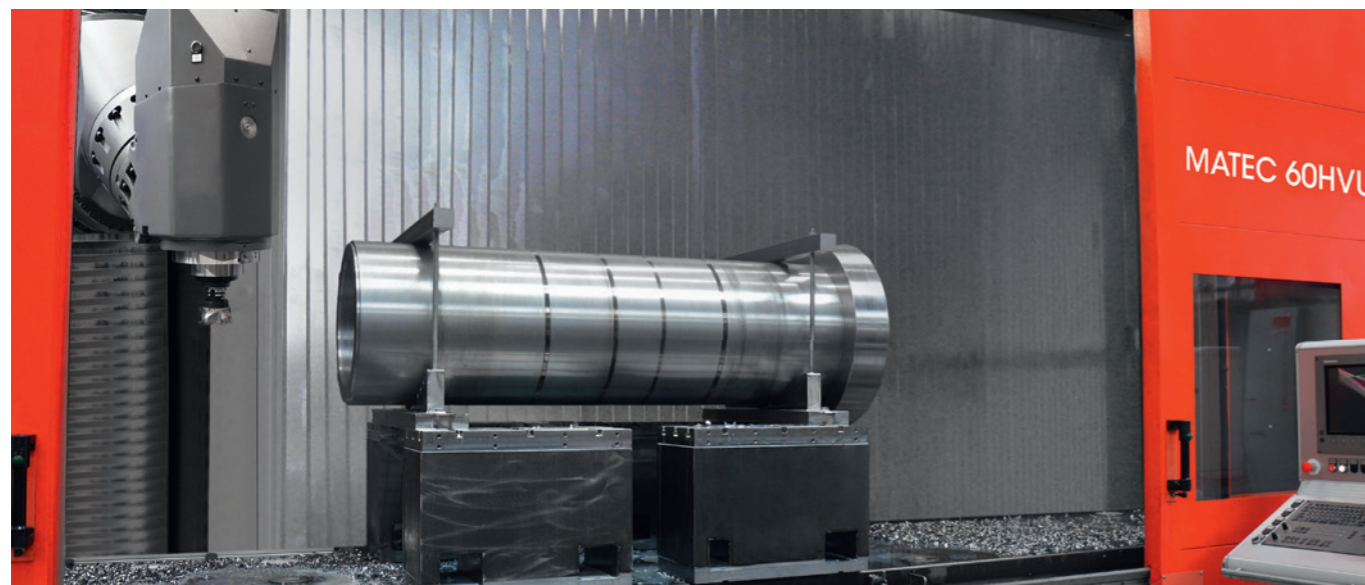
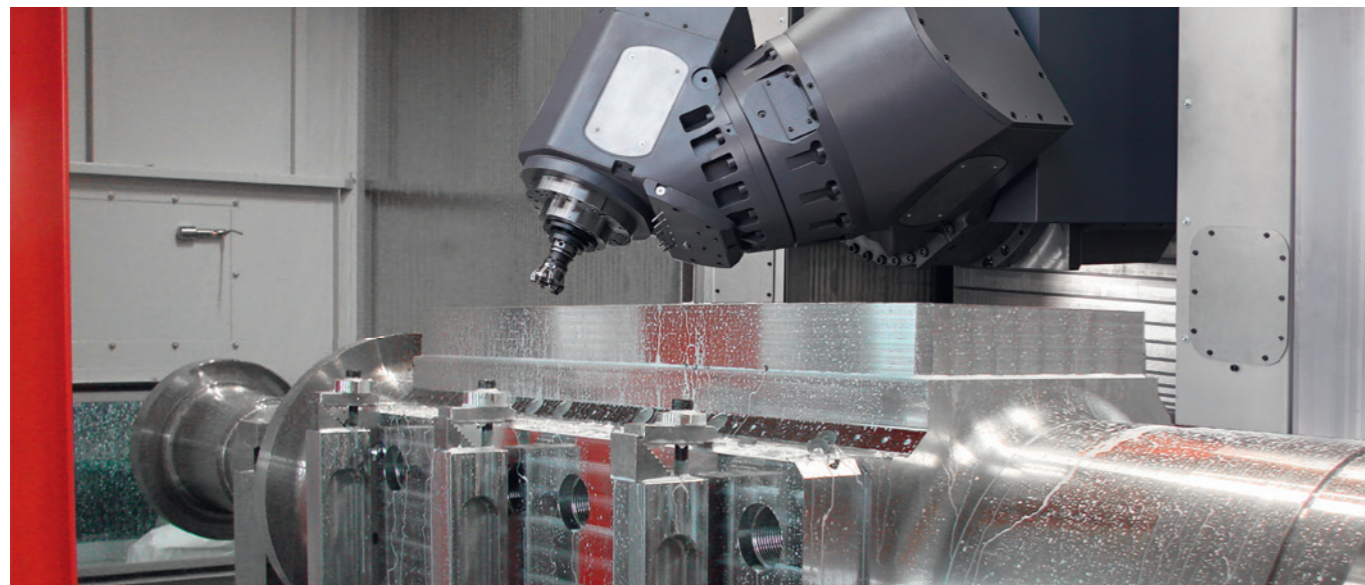

## Technical data Modular Group HVU | U\*

Work area	Unit	30HVU   U**and 50HVU   U**	60HVU   U**	70HVU   U**
X-axis	mm	3,000 - 12,000		3,400 - 12,500
Y-axis	mm	1,125	1,400	1,630
Z-axis	mm	1,300	1,300	1,800
Distance spindle nose   machine table (vertical)	mm	1,200	1,200	1,700
Distance spindle centre   machine table (horizontal in X-direction)	mm	350		305
Distance spindle centre   machine table (horizontal in Y-direction)	mm	200		200
<b>2-Axis swivel head (HVU)   1-Axis swivel head (U)</b>		<b>30HVU   U**</b>	<b>50HVU   U**</b>	<b>60HVU   U**</b>   <b>70HVU   U**</b>
<b>A-axis torque drive (45° plane)</b>				
Swivel angle	Degrees	+/- 180°		
Direct path measuring system	sec.	+/- 1.7"		
Torque   Holding force	Nm	5,000   5,600		
<b>B-axis worm drive (not with U-version)</b>				
Swivel angle	Degrees	+/- 180°		
Direct path measuring system	sec.	+/- 1.9"		
Torque   Holding force	Nm	4,200   12,000		
<b>Main spindle   Motor spindles available in other performance classes as an option (see page 52 - 53)</b>				
Tool holder		HSK 63   SK40*	HSK100   SK50*	HSK 63   SK40*   HSK100   SK50*
Speed	1/min	9,000 - 42,000	8,000 - 15,000	9,000 - 42,000   8,000 - 15,000
Power max.	kW	50	92	50   92
Torque max.	Nm	230	690	230   690
<b>Tool magazine (travelling)</b>				
Tool places (main magazine)	pcs.	60	40   60*	60   80*   40   60*
Tool places with auxiliary magazine max.		280	196	300   196
Tool length	mm	450	450	450   450
Tool Ø (all places occupied)	mm	70	104	70   104
Tool Ø (secondary places free)	mm	200	200	200   200
Tool weight max.	kg	10	20	10   20
<b>Tool changer (travelling)</b>				
Changing system		Shuttle		
Tool change position		in any X-position   Y-position: 0		
<b>Axis drives</b>				
Ball screw drive (standard)				
Rapid traverse   Feed rate	m/min.	30		
Rack and pinion drive*				
Rapid traverse   Feed rate	m/min.	48		
<b>Machine table</b>				
Table length	mm	Travel X-axis + 500		
Table width with Y-1,125   1,400	mm	1,155   1,235	1,700	
T-slots according to DIN 650	mm	18 <sup>H7</sup>		
Number of T-slots for Y-1,125   1,400	pcs.	11	13	
Distance between slots for Y-1,125   1,400	mm	100	125	
Table load max.	kg/m <sup>2</sup>	1,500   2,500	2,500	
<b>Accuracies</b>				
Positioning accuracy up to 2,000 mm	mm	0.010		
Repeatability (absolute)	mm	0.003		
Positioning tolerance DIN/ISO 230-2 (1,000)	mm	0.008		

\* Option

\*\* The U-version is identical to the HVU-version except for the 1-axis universal head

## Special solutions

**Pendulum machining with two work areas and removable partition wall.**

In the example, multi-sided machining of excavator arms on rotary table, fixture bridge and counter bearing. Universal clamping device adjustable to different workpiece sizes.

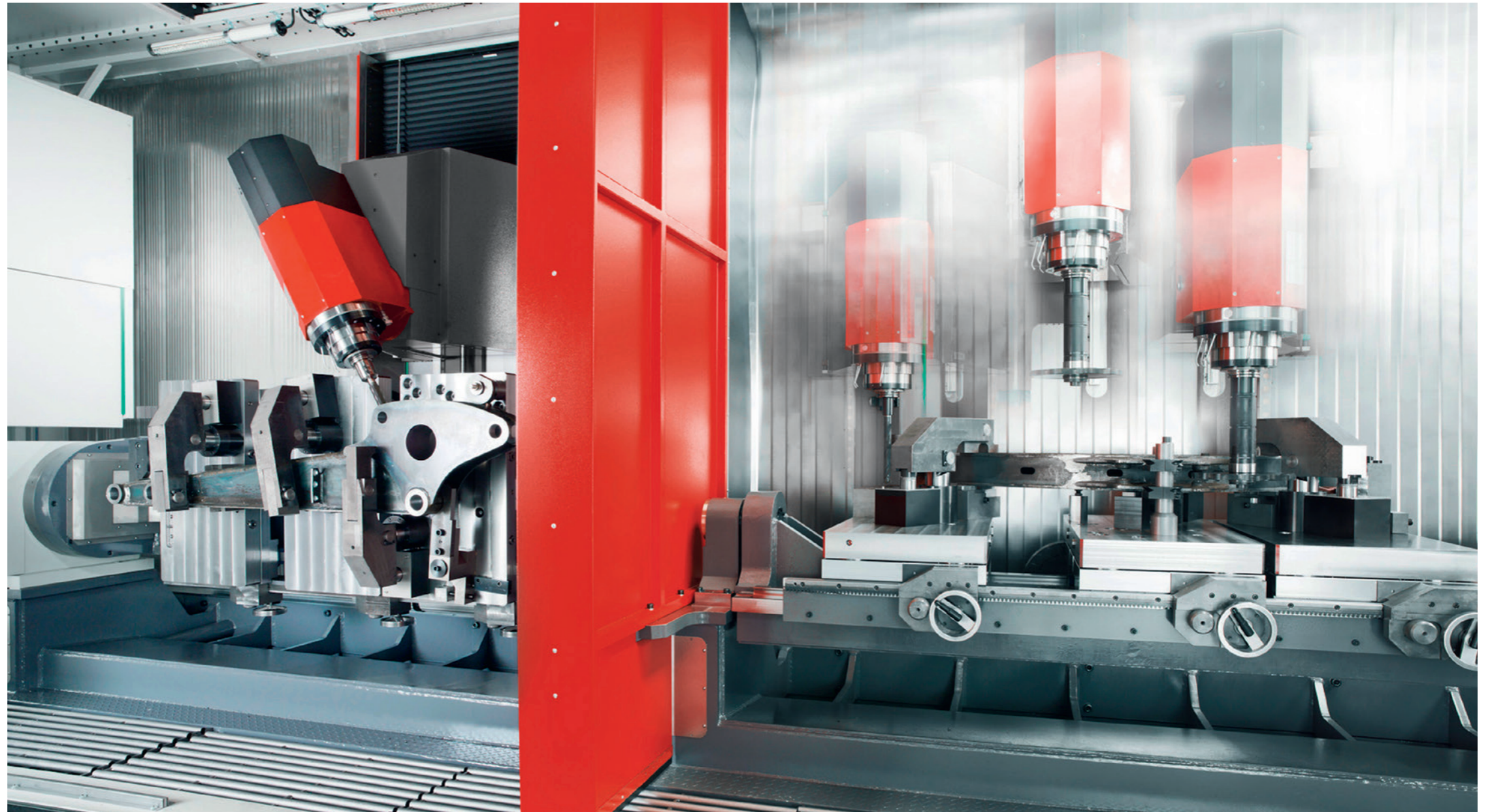

**Production of truck front axles.**

Multifunctional fixture with automatic workpiece centring. Complete machining in one clamping position.

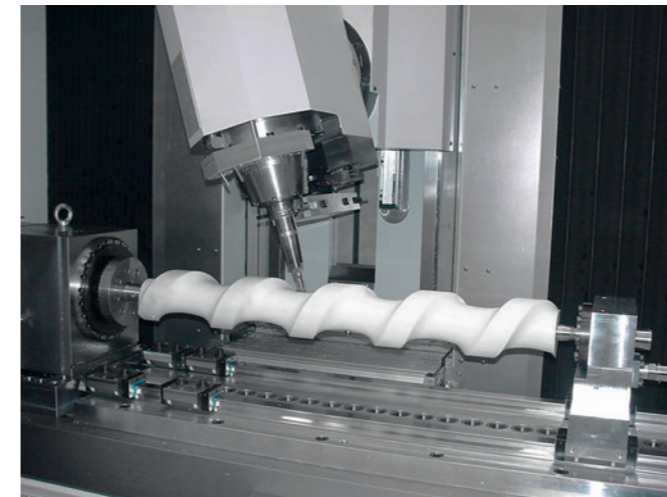

**Special device for the production of steel and plastic transport screws.**

Prepared for supporting steady rests with corresponding workpiece lengths.

## Special solutions

### Machining centres with two independent moving columns

Highly productive manufacturing cells for efficient production.  
Complete machining through additive machining units and integrated automation.  
Technical data based on modular group.



#### Technical details

- Machining of profile-like workpieces of different material groups
- Single or multiple clamping
- Simultaneous machining on the same workpiece or separately in the other work area
- Automatically retracting partition wall to form two work areas
- Production of different workpieces in each work area
- Automatic changeover to other workpiece dimensions
- Clamping devices on the slide unit can be infinitely positioned via programme



## MATEC 30HV duo

### Mill turn centre with simultaneous machining

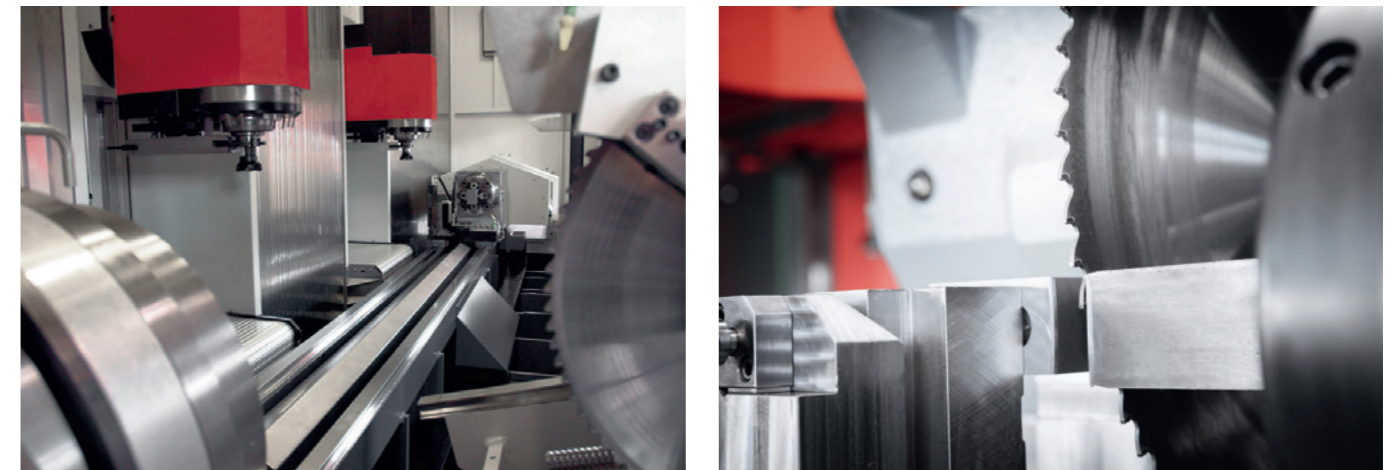

#### Technical details

- Two independent moving columns with swivel head  
X = 4,000 mm, Y = 600 mm, Z = 800 mm
- Automatic bar feeder
- CNC rotary table with chuck passage up to Ø 120 mm
- Transfer spindle (positioning | turning) on slide unit
- 2-Axis CNC sawing unit, saw blade Ø 450 mm
- 5-Axis workpiece gripper for workpiece removal
- Removal system for workpieces and remnants

## Special solutions

### Machining from the bar

Highly productive manufacturing cells for efficient production.  
Complete machining through additive machining units and integrated automation.  
Technical data based on modular group.



#### Concept

With this machine concept, all process steps from feeding the bar profile, 6-sided machining in two clamping positions and automatic unloading are combined in a single machine.

This results in a fully automatic production process. This in turn guarantees the highest precision and repeatability over the entire production period. The concept is thus not only able to optimise production, but also to generate savings in the mid double-digit range.

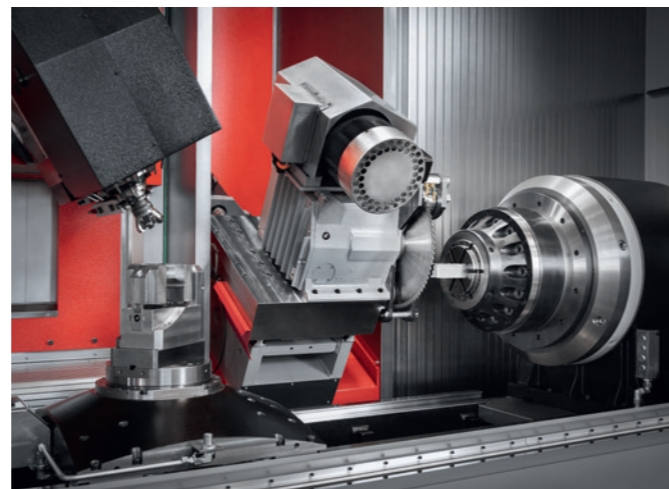

#### Technical details

- Moving column machining centre with swivel head
- Automatic bar feeder
- CNC rotary table, horizontal, with collet chuck, passage  $\varnothing$  160 mm
- Tailstock for workpiece support
- 2-Axis CNC sawing unit, saw blade  $\varnothing$  490 mm | 16 kW
- Transfer slide with horizontal CNC rotary table and clamping station
- 3-Axis workpiece gripper for workpiece removal
- Removal system for workpieces and remnants

#### Application range of High-Production-Line

- Materials from high-strength steel to plastics
- Elongated workpieces with multi-sided machining
- Profiles of different dimensions
- Shafts, tubes, traverses and the like
- Single part or small batch production from solid material

#### Technical data

##### Traverse paths

X-axis:	3,000 mm
Y-axis:	825 mm
Z-axis:	1,100 mm

##### Swivel head

Swivel angle:	$\pm 105^\circ$ infinitely variable
Positioning accuracy:	$\pm 3''$

##### Tool magazine

Tool system:	SK40   HSK63
Tool magazine, travelling:	48 places
Tool $\varnothing$ :	max. 200 mm
Tool length:	max. 340 mm

##### Main spindle drive

Motor spindle HSK63	
Speed:	15,000 1/min
Drive power:	max. 30 kW
Torque:	max. 230 Nm

##### Rapid traverse | Feed rate

48 m/min.

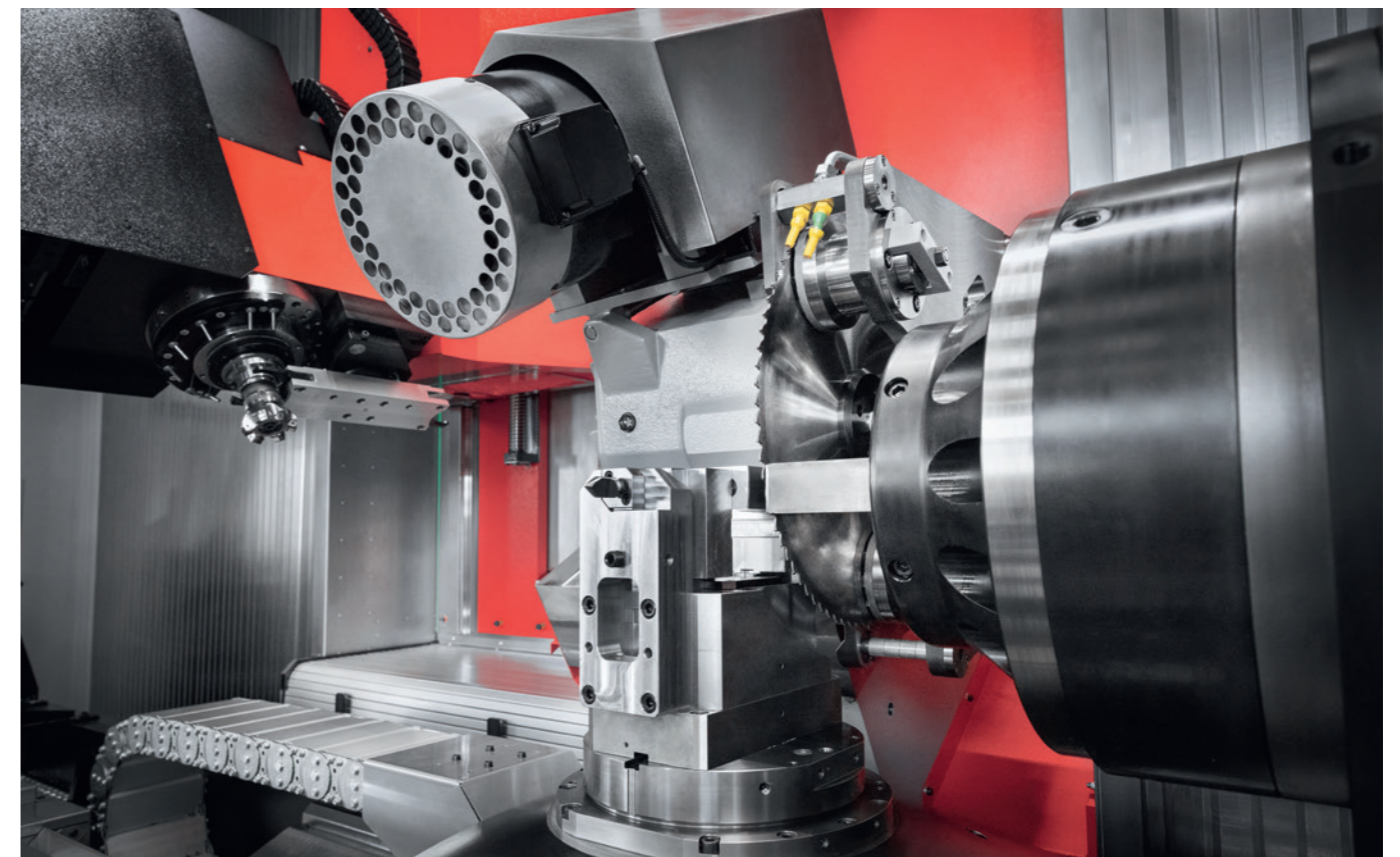

Transfer station with vice on linear axis "U" and rotary axis "C", 2-axis CNC sawing unit.



## MATEC-Aerospace

### The other kind of machining

Maximum chip removal volume, high surface quality, exact contour accuracy.  
Highest economic efficiency!



#### Technical data

- Dynamic package rack and pinion drive 48 m/min.
- Acceleration 5m/sec<sup>2</sup>
- Tool holder HSK63 F80
- 30,000 1/min.
- High performance spindle
 

Smax.	159 kW   124 Nm
S1 100 %	120 kW   83 Nm
- Machining capacity in aluminium approx. 9,000 cm<sup>3</sup>/min.
- High-performance coolant system, temperature-controlled, 650 l/min.
- Workpiece cleaning with air curtain
- Oil mist extraction system 2,300 m<sup>3</sup>/h

#### Selectable variants of the basic machines - Traverse paths

X-axis:	2,000 to 8,300 mm
Y-axis:	930   1,630 mm
Z-axis:	950   1,650 mm

#### Tool management

60 to 220 tool places



## Modular automation solutions

### Individual complete solutions for all MATEC machines

Modules that interlock perfectly  
Integration of various automation systems according to customer requirements

- Pallet handling
- Workpiece handling
- Bar feeder
- Pallet changer for gantry machines up to pallet size 4,000 x 3,000 mm

Automation concept with pallet pool (fig. above) for individual single and small batch production

- High-performance machining centre MATEC 50HV | HSK100
- Mill turn centre version
- Variable pallet storage as linear system with several levels
- Double additional tool magazine with 250 places
- Pallet size 1,000 x 1,000 mm

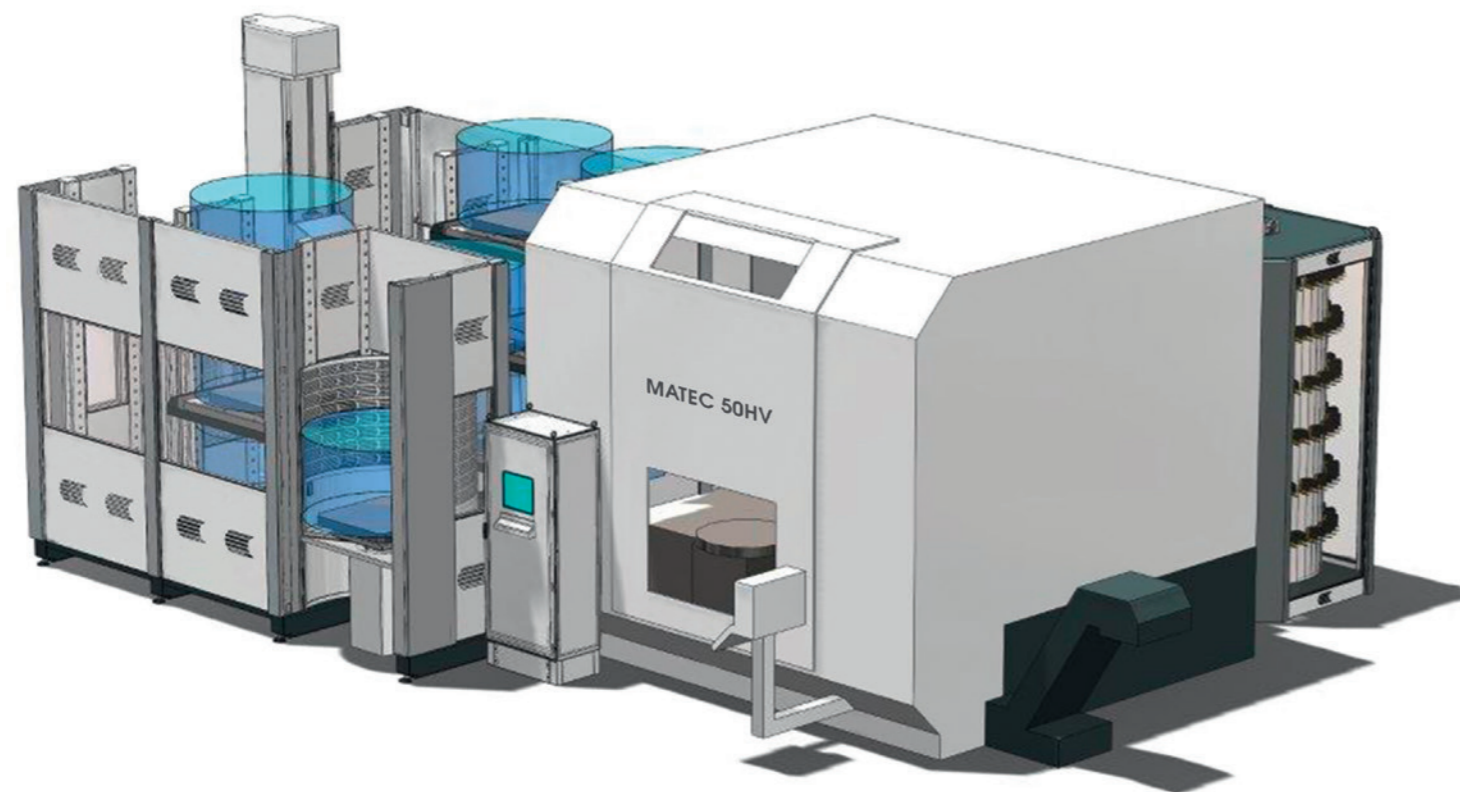

#### Mobile robot cell

for small and medium batch production.  
Can also be used on other MATEC machines due to easy relocation.

- 6-Axis industrial robot

- Automatic gripper change
- Alignment and turning station for workpieces
- Workpiece storage in pull-out drawers principle
- Simple operation
- Quick changeover to other workpieces



## Power and torque for every application Motor spindles in performance class HSK63 | SK40

Options for both performance classes:

- Linear growth compensation
- Vibration sensor
- Hydraulic clamping for mill turn centre

Spindle speed 10,000 1/min  
Drive power 50/46/30 kW  
(25/40/100% DC)  
Torque 217/200/130 Nm  
(25/40/100% DC)

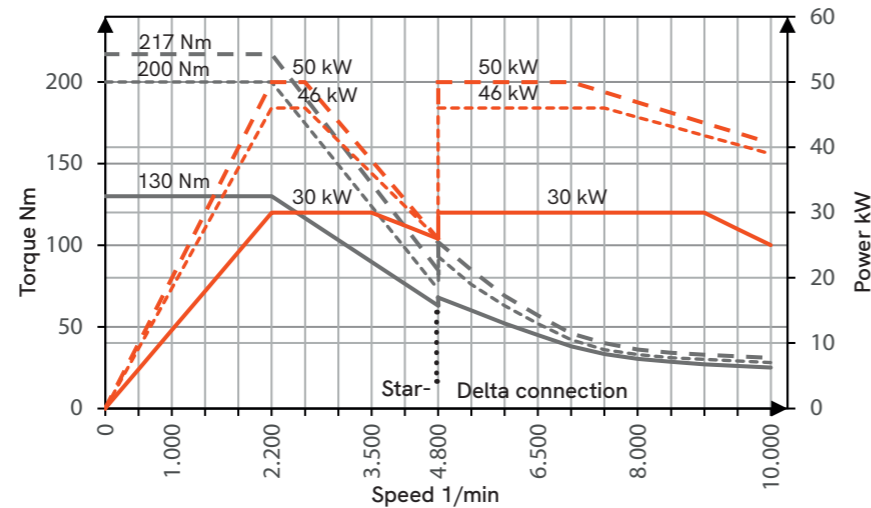

Spindle speed 12,000 1/min  
Drive power 50/46/30 kW  
(25/40/100% DC)  
Torque 217/200/130 Nm  
(25/40/100% DC)

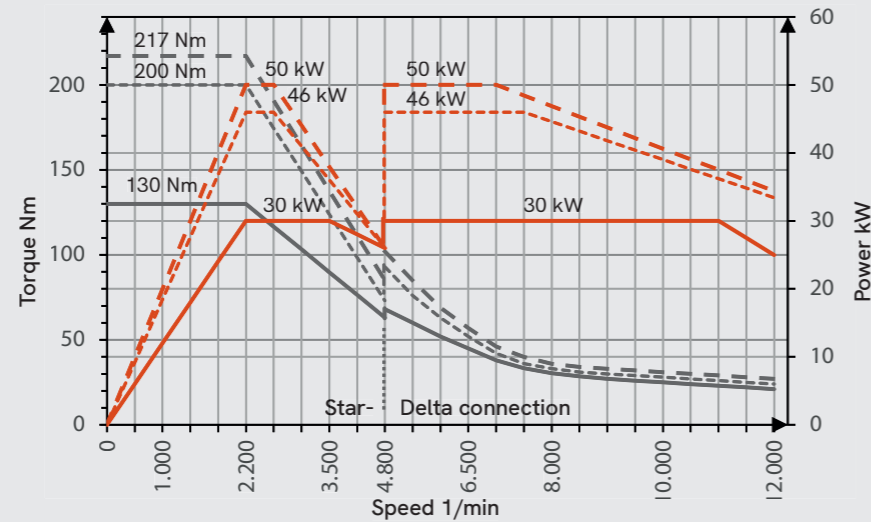

Spindle speed 15,000 1/min  
Drive power 50/46/30 kW  
(25/40/100% DC)  
Torque 217/200/130 Nm  
(25/40/100% DC)

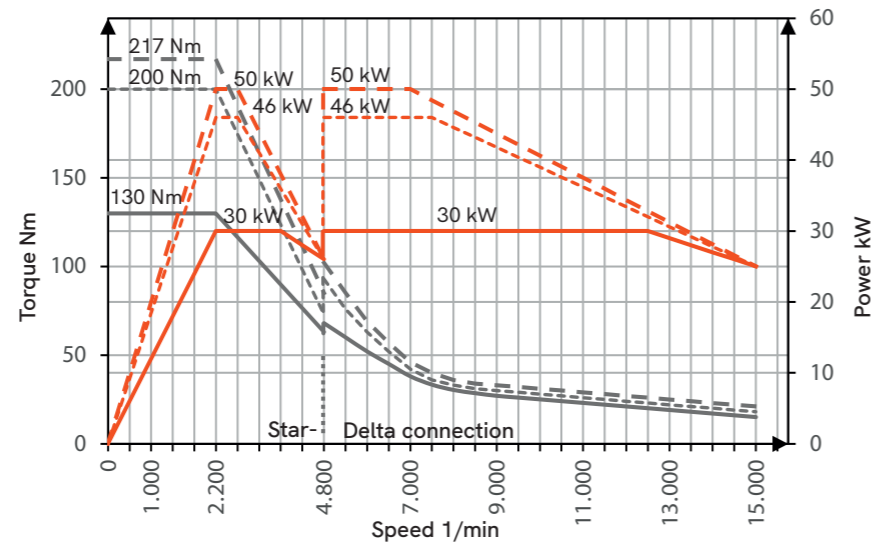

— S6 25% DC    - - - S6 40% DC    — S1 100% DC

## Motor spindles in performance class HSK100 | SK50

Spindle speed 10,000 1/min  
Drive power 86/70/50 kW  
(25/40/100% DC)  
Torque 690/560/400 Nm  
(25/40/100% DC)

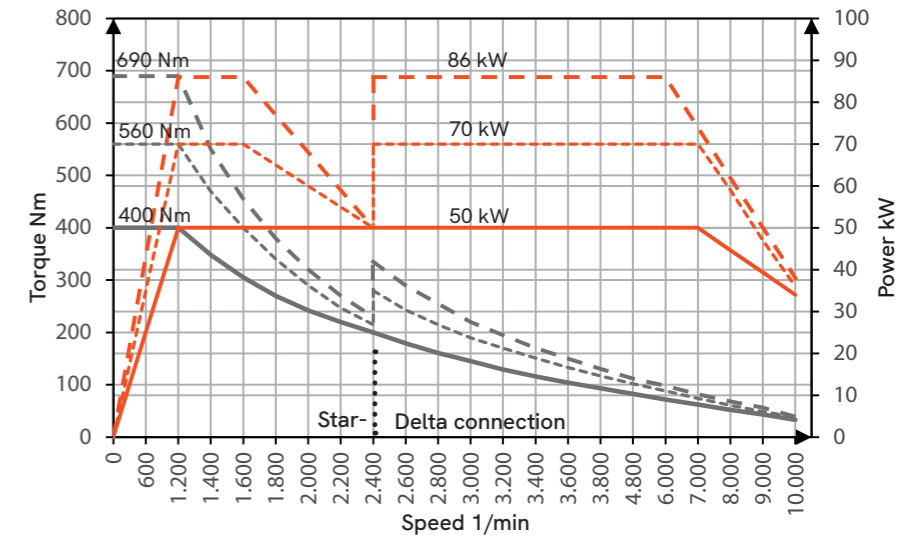

Spindle speed 12,000 1/min  
Drive power 96/84/74 kW  
(25/40/100% DC)  
Torque 521/452/300 Nm  
(25/40/100% DC)

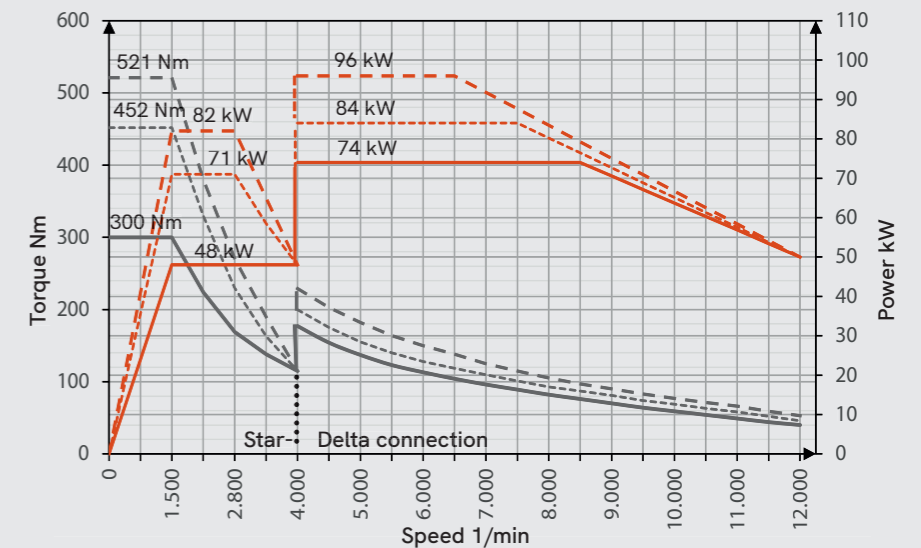

Spindle speed 15,000 1/min  
Drive power 92/75/60 kW  
(25/40/100% DC)  
Torque 535/445/300 Nm  
(25/40/100% DC)

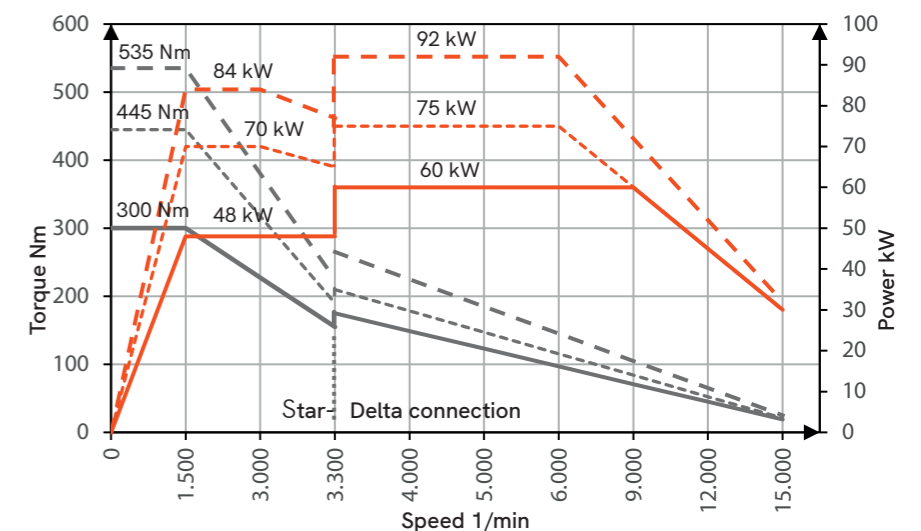

— S6 25% DC    - - - S6 40% DC    — S1 100% DC

## Technical equipment: Magazines

### Machine-related options

#### Tool changing system with shuttle

- System assembly group from Y = 825 mm and Z = 1,100 mm
- Shuttle changer outside the machining area. This allows tools to be changed in any X-axis position.
- Up to 80 tool places
- Travelling tool magazine

#### Side magazine (not shown)

- With separate tool changer
- Available up to 80 tools
- Version with lateral lift door



#### Additional magazine up to 280 tools

With double gripper and automatic tool supply

#### Second control panel at the tool loading station

Tool management for standard magazine and additional magazines directly at the station.

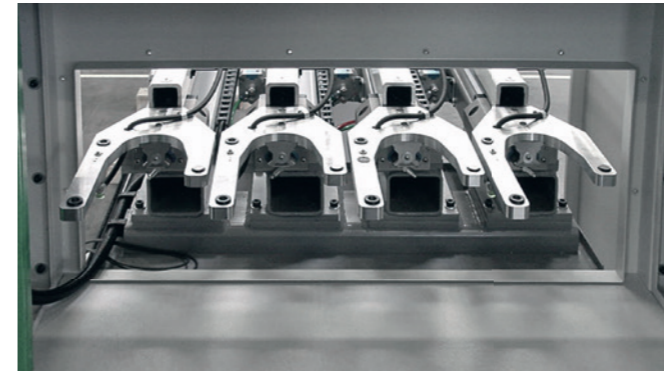

#### Pick-up stations | drill head fixation

- Pick-up station for oversized tools, such as angle heads, multi-spindle heads, attachment spindles, etc.
- Pick-up magazine can be mounted laterally on the right or left side



#### Angular heads

- Design and function available individually
- Example of angle head with 360° infinitely variable positioning via NC axis
- Oil-air lubrication for angle heads
- Stop block for angle head locking
- Three-point support



#### Additional screen

Camera system operated via touch screen

## Technical equipment Options

### Rotary tables

For all-round machining of the workpieces, rotary tables are available in almost all variants and drive types.

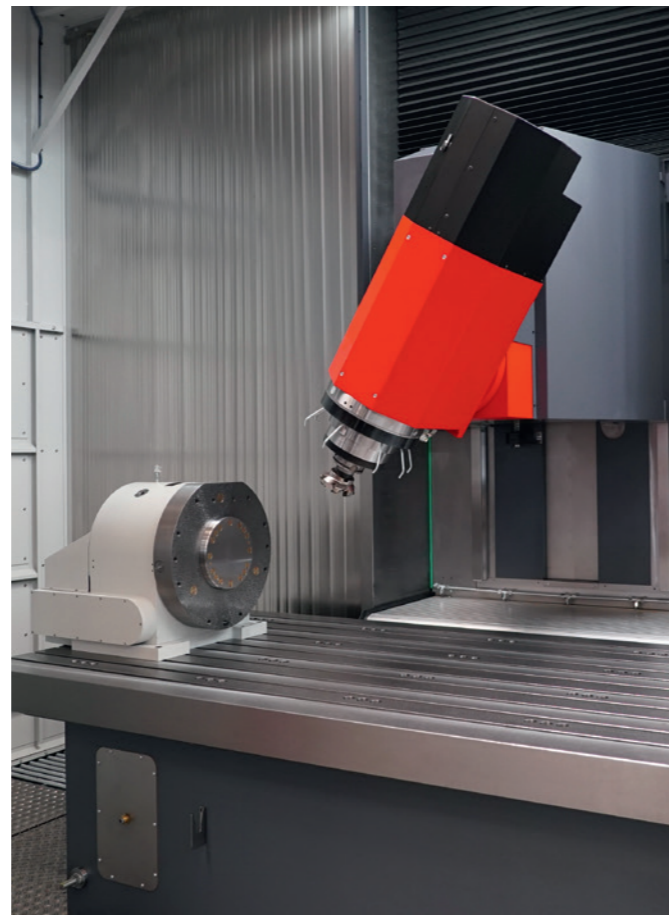
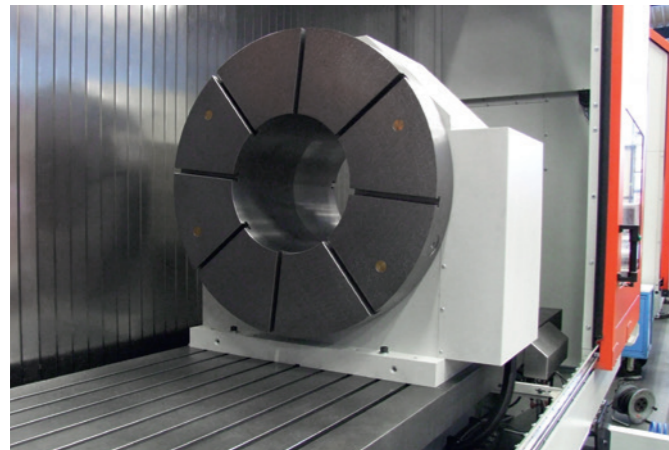
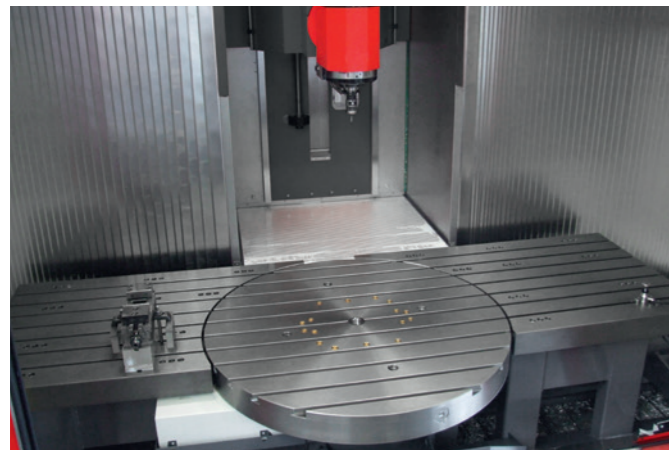

### X-axis drives

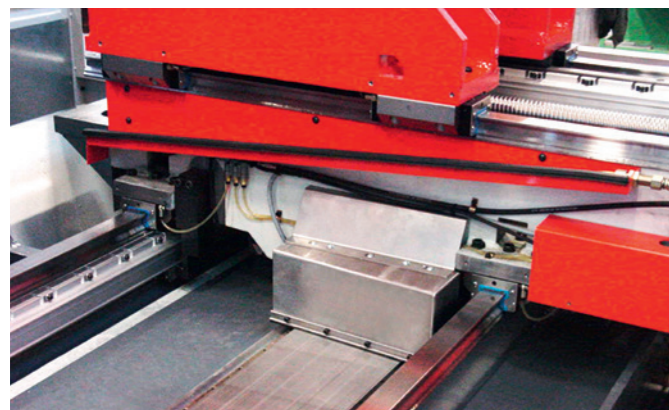

#### Linear drive up to 100 m/min.

In the case of longer X-axes and highly dynamic machining processes, a linear drive can make a significant contribution to reducing piece times.



#### Rack and pinion drive up to 48 m/min.

For dynamic and powerful machining of large parts.

### Coolant systems

Adapted to all machine sizes and customer requirements.

- Internal coolant supply up to 120 bar
- Coolant tank up to 10,000 litres
- Application-specific filter systems
- Additional pumps for automation and special applications
- Coolant temperature control
- Air through spindle
- Air/coolant high pressure at outer nozzles
- Circulation control coolant tank
- Oil skimmer
- Automatic filling of the coolant system
- Connection to central coolant system
- Minimum quantity lubrication



### Coolant systems with edge gap filter



### Slat-band conveyors in special sizes



## Technical equipment Options for process technology



**Balancing of workpieces on the mill turn centre**  
For balancing rotationally symmetrical workpieces. The position and size of the unbalance are determined automatically.



**Gear cutting**  
Concept for complete machining of gears or individual process steps.

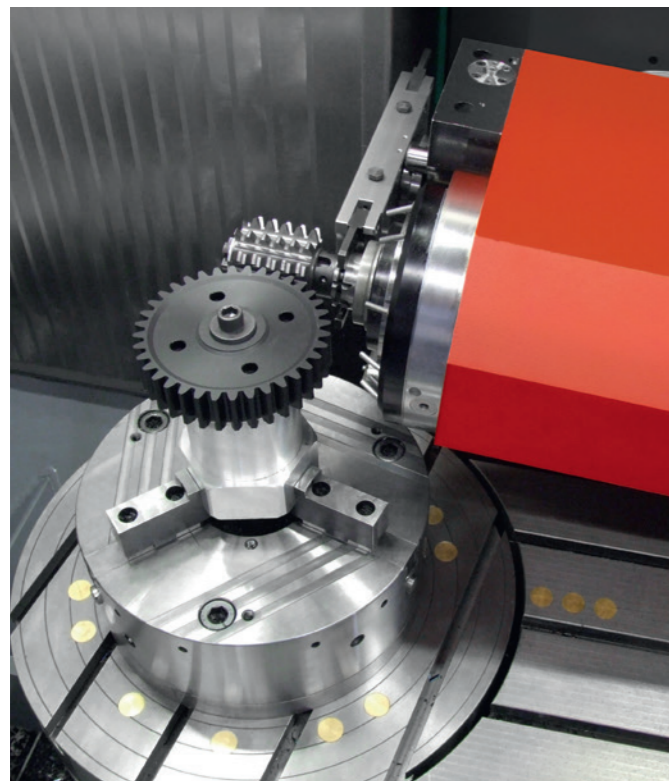

**Possible manufacturing processes:**

- Gear hobbing
- Single tooth hobbing with form cutter
- Internal and external skiving
- Shaping

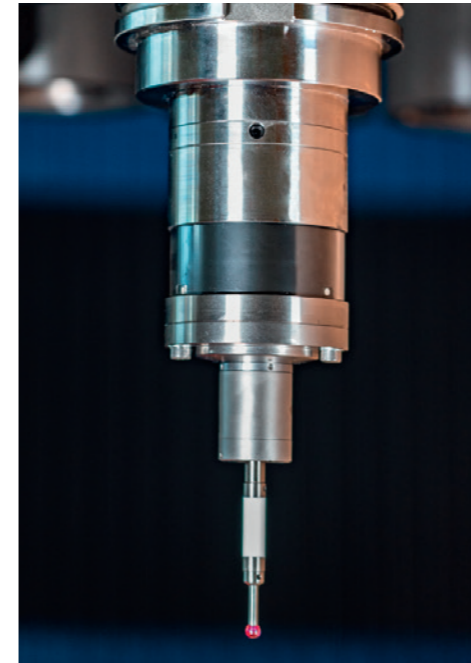

**Radio measuring probe**

- Recording of the workpiece position
- Workpiece measurement and logging
- Creation of customised measuring cycles
- Visual evaluation of measurement results



**Handwheel**  
for manual operation of machine tools. Version with cable or via radio.

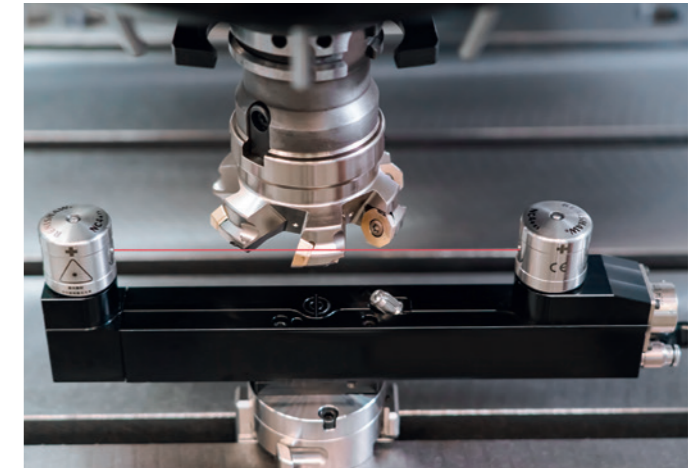

**Laser systems**  
for tool measurement and tool breakage control with quick-change system.



**Radio table touch probe**  
for tool measurement and tool breakage control. Including quick-change system.

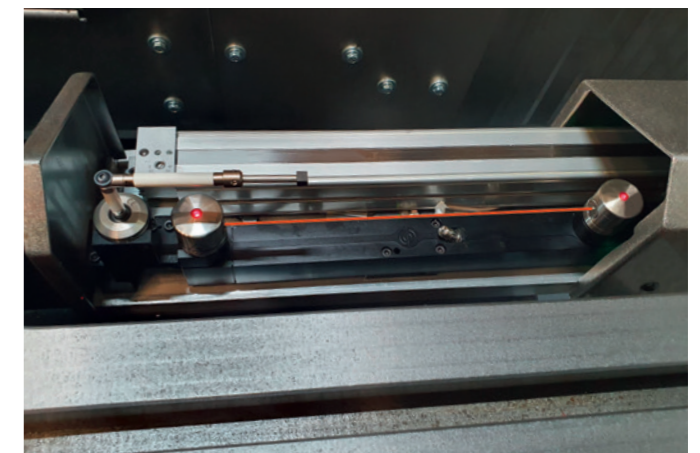

**MATEC-specific solution with fully integrated laser in the machine table**  
and retractable chip guard.

Numerous other options can be made available on request.

## Other machine series

### Gantry series

### Travelling gantry

### Performance class HSK63 | HSK100

5-Axis gantry machines with infinitely variable 2-axis fork or universal head

- Table version
- Floor-running
- Floor-running with movable gantry beam (W-axis)

#### Traverse paths:

X-axis up to 20,000 mm  
Y-axis up to 5,300 mm  
Z-axis up to 2,900 mm

Other sizes can be made available on request.



## Stationary gantry | Moving machine table

#### Specifications

MATEC 30PP | MATEC 40PP  
With pallet changer

MATEC 30PT | MATEC 40PT  
As single station machine

up to 5 replaceable heads (more heads on request)

- X-axis: up to 7,000 mm
- Y-axis: up to 4,800 mm
- Z-axis: up to 2,100 mm
- Pallet size 2,000 x 2,000 to 6,000 x 3,000 mm, corresponds to the workpiece size, for a tool length of 250 mm
- 2-axis universal head (infinitely variable), optional with 2-axis fork head
- Speeds up to 30,000 1/min
- Motor spindle up to 159 kW
- Torque up to 690 Nm
- Axis drives with ball screw, optional rack and pinion drive or linear drive
- Tool capacity 40 bis 680 places or tool handling with robot for up to 250 tools
- Pallet changer for 2 to 4 pallets
- Workpiece weight 1 t/m<sup>2</sup>, optionally higher payload
- Fully enclosed work area, prepared for mist collection
- Manual pallet exchange

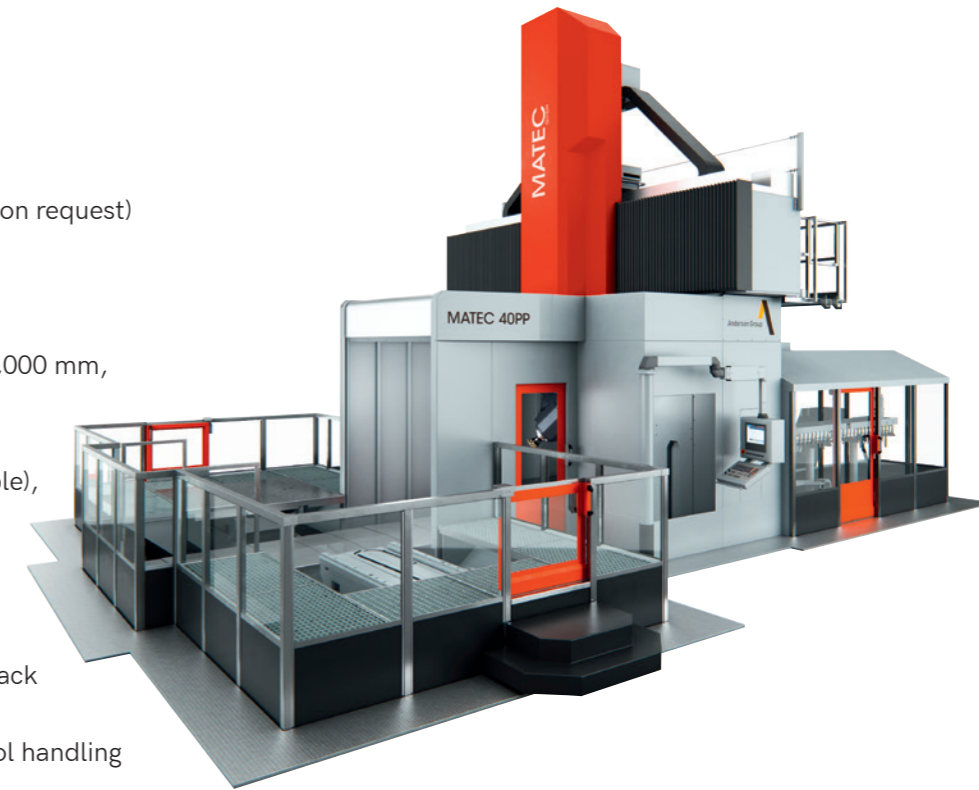

## Other machine series Long bed and swivel table series

### Long bed series

**MATEC 30L**  
Vertical machining centre



**MATEC 30LD**  
Double spindle  
Fixed spindle distance 400 mm | 550 mm  
Option: with compensating second Z-axis



### Swivel table series

#### Series production

30S Single spindle  
30SD Double spindle

**MATEC 30S or 30SD**  
with 180° swivel table and two machining areas.  
For difficult-to-machine materials.



## Other machine series Standard machine series

**MATEC VMC**  
Vertical machining centre

Designed for single-part and series production



**MATEC FUV620 | FUV720**  
5-axis universal machining centres

**MATEC FUV800**  
5-Axis gantry machining centres

Perfectly suitable for manufacturing intricate parts and shapes



**MATEC FUV170T | FUV190T**  
Travelling Column 5-Axis Machining Centres  
Performance class HSK63

FUV170T	FUV190T
X-axis 1,700 mm	X-axis 1,900 mm
Y-axis 540 mm	Y-axis 540 mm
Z-axis 460 mm	Z-axis 460 mm



**MATEC GPC**  
Gantry Centre  
Performance class HSK100

X-axis	2,200 to 4,200 mm
Y-axis	1,700 to 2,100 mm
Z-axis	900 to 900 mm





## Company headquarters

MATEC GmbH  
Wilhelm-Maier-Str. 3  
D-73257 Köngen  
Germany  
Tel.: +49 7024 983 85 - 0  
sales@matec.de  
www.matec.de

## Branch office Switzerland

MATEC SCHWEIZ AG  
Alte Steinhäuserstrasse 3  
CH-6330 Cham  
Switzerland  
Tel.: +41 58 058 55 00  
sales@matec-schweiz.ch  
service@matec-schweiz.ch  
info@matec-schweiz.ch  
www.matec-schweiz.ch



Subject to technical changes. Illustrations may contain options.

